

The background of the slide features a sunset sky with a gradient from orange at the bottom to dark blue at the top. A crescent moon is visible in the upper left quadrant. Several large radio telescope dishes are silhouetted against the sky, with their complex support structures also visible. The dishes are arranged in a line, with the largest one in the foreground on the right and smaller ones further back and to the left.

# Interferometría...

# ¿Magia o Ciencia?

Rubén Herrero-Illana

# Introduction

- $\theta = 1.22 \frac{\lambda}{D}$

# Introduction

- $\theta = 1.22 \frac{\lambda}{D}$
- Hubble resolution: 0.05'' (2.4m mirror).

# Introduction

- $\theta = 1.22 \frac{\lambda}{D}$
- Hubble resolution: 0.05'' (2.4m mirror).
- Radio (1 cm)  $\longrightarrow$  50 Km mirror!

# Introduction

- $\theta = 1.22 \frac{\lambda}{D}$
- Hubble resolution: 0.05" (2.4m mirror).
- Radio (1 cm)  $\longrightarrow$  50 Km mirror!



# Introduction

- $\theta = 1.22 \frac{\lambda}{D}$
- Hubble resolution: 0.05" (2.4m mirror).
- Radio (1 cm)  $\longrightarrow$  50 Km mirror!



# Basics

# Double slit experiment

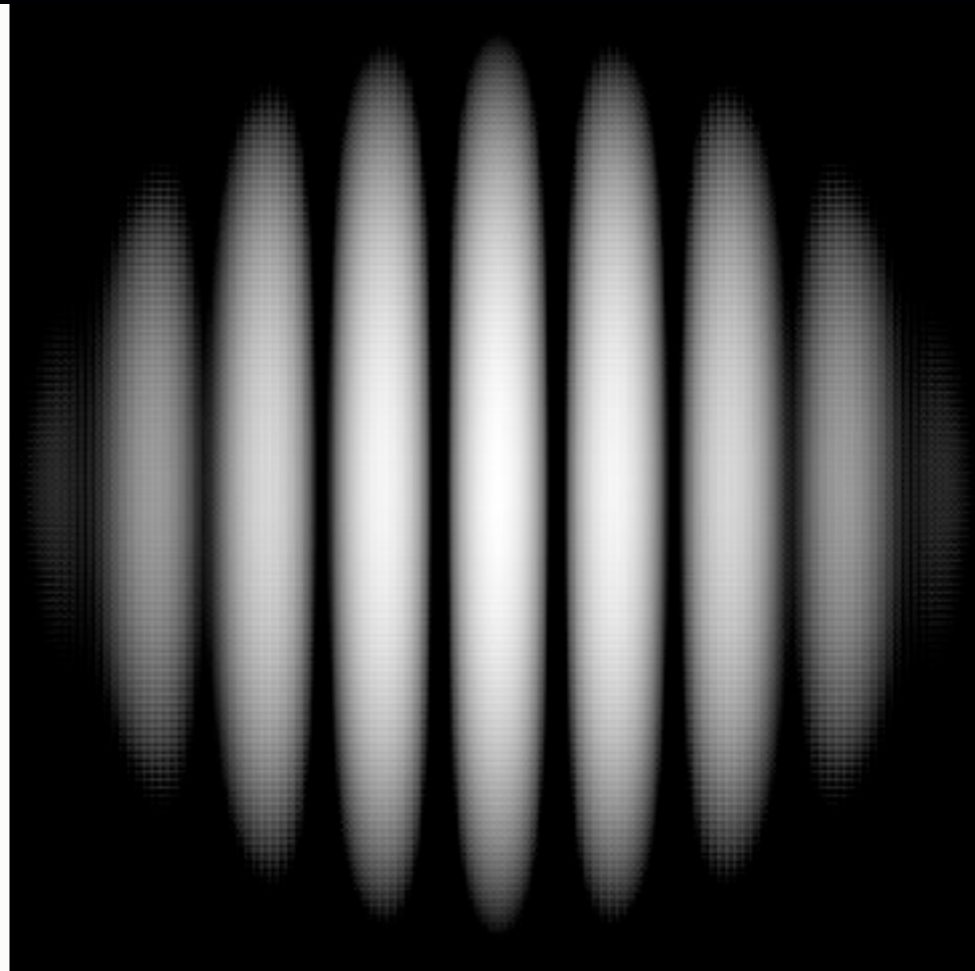
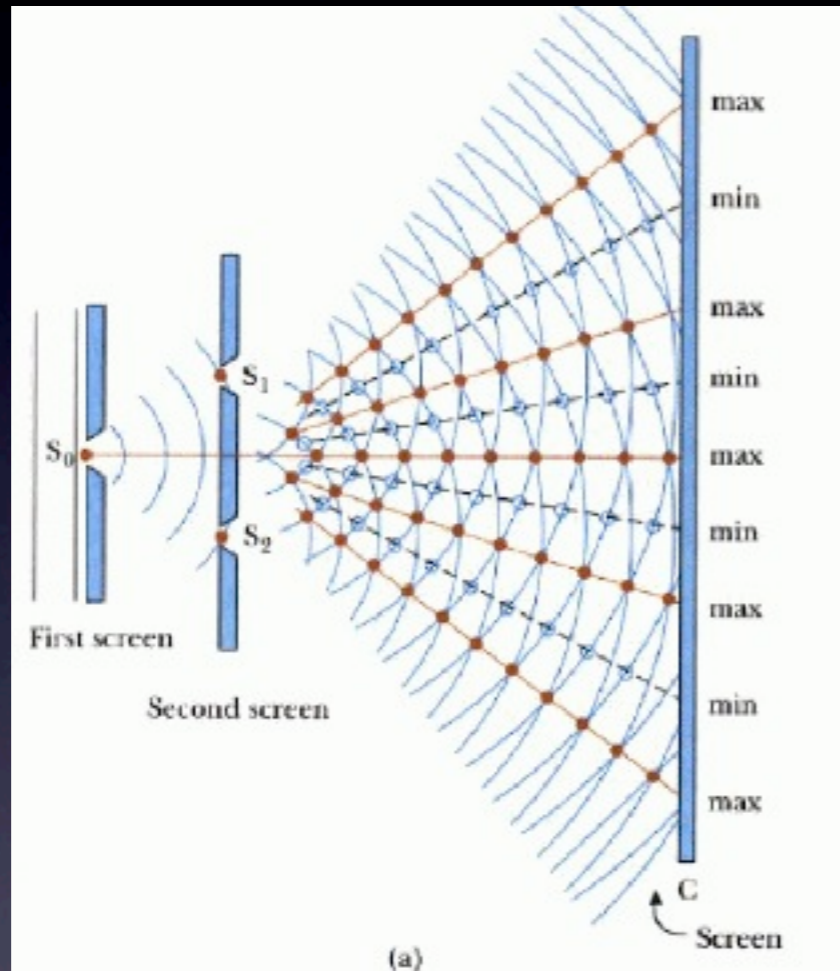



# Double slit experiment

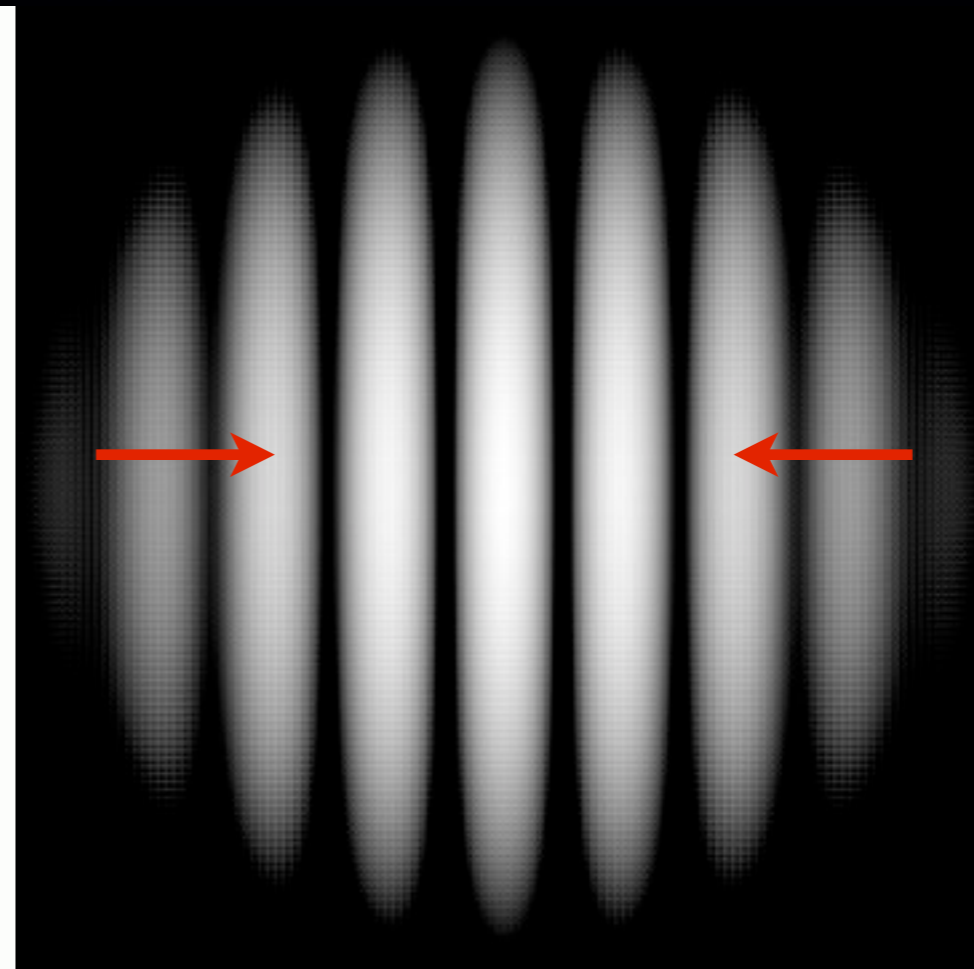
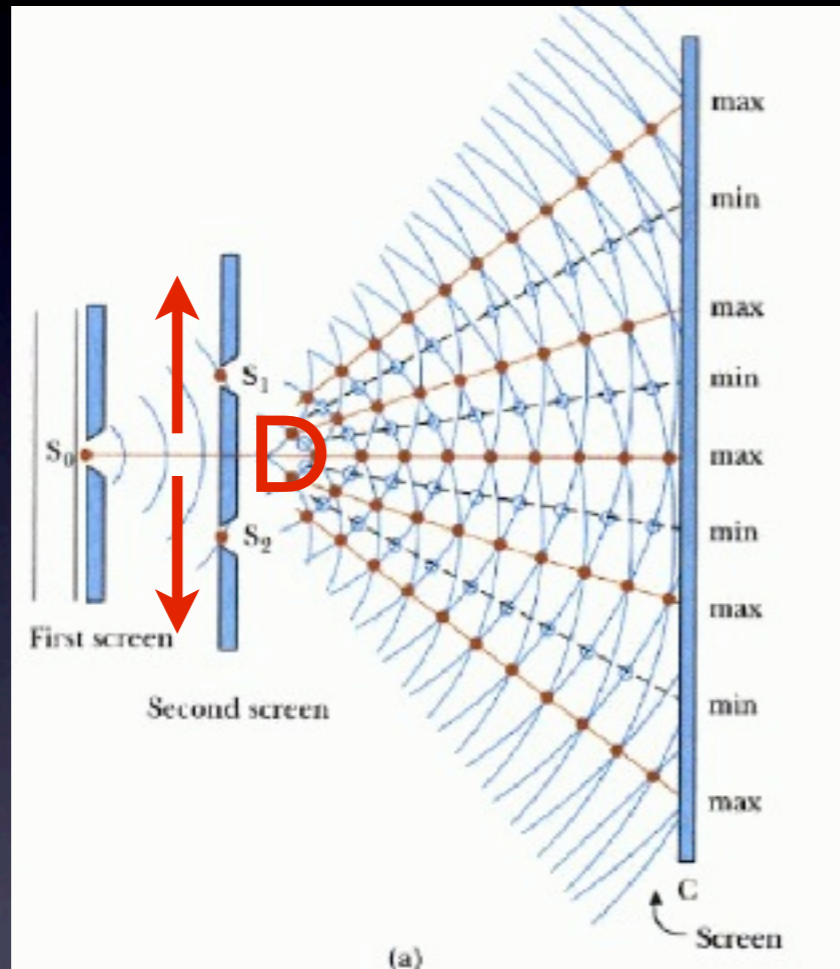

# Double slit experiment

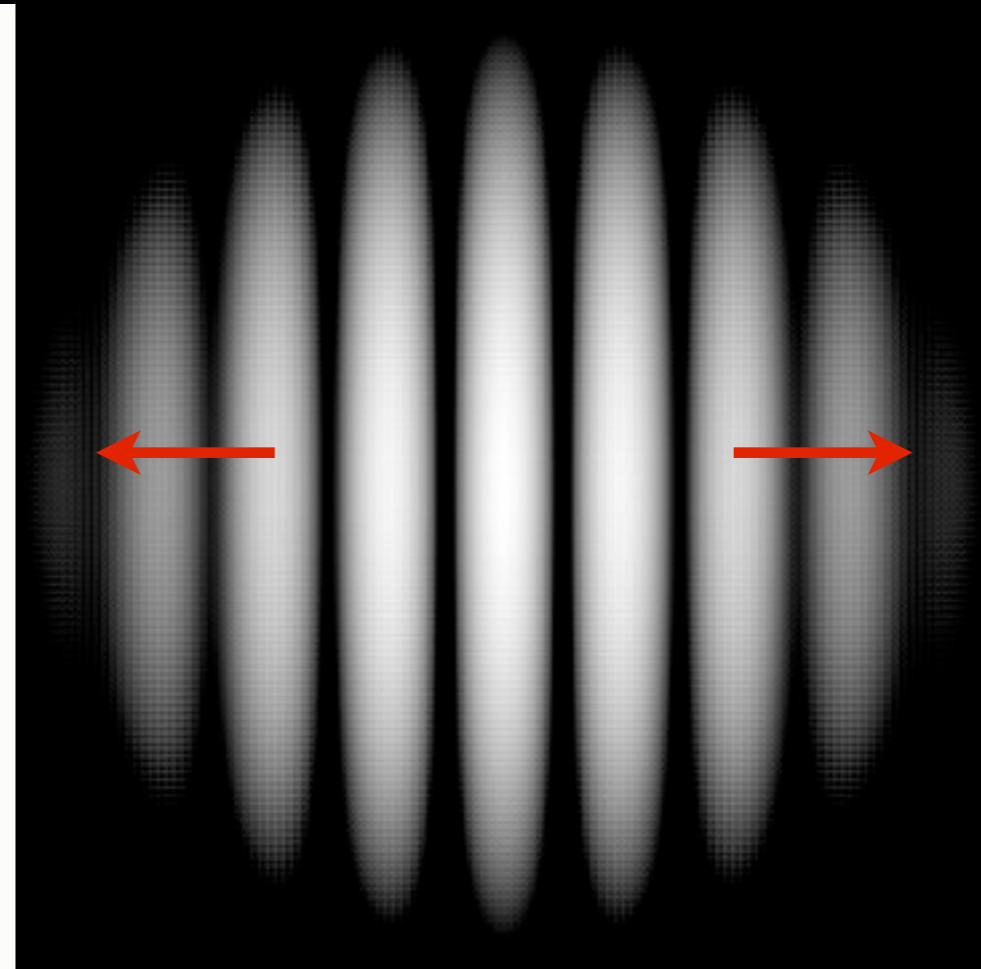
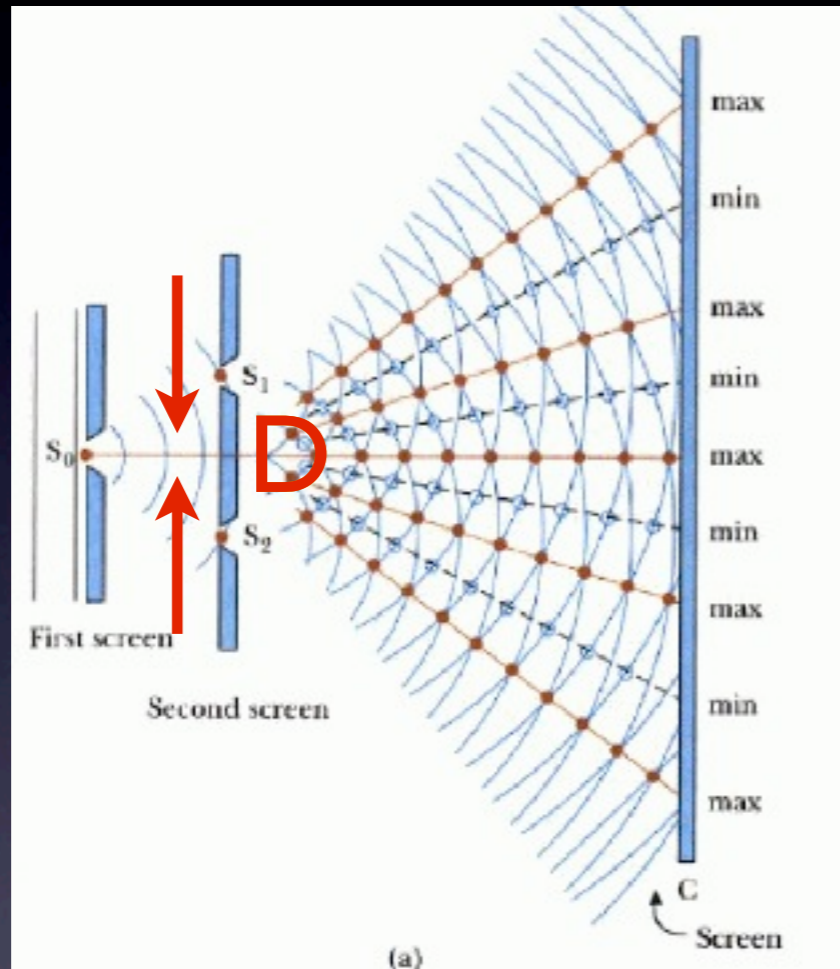

# Double slit experiment

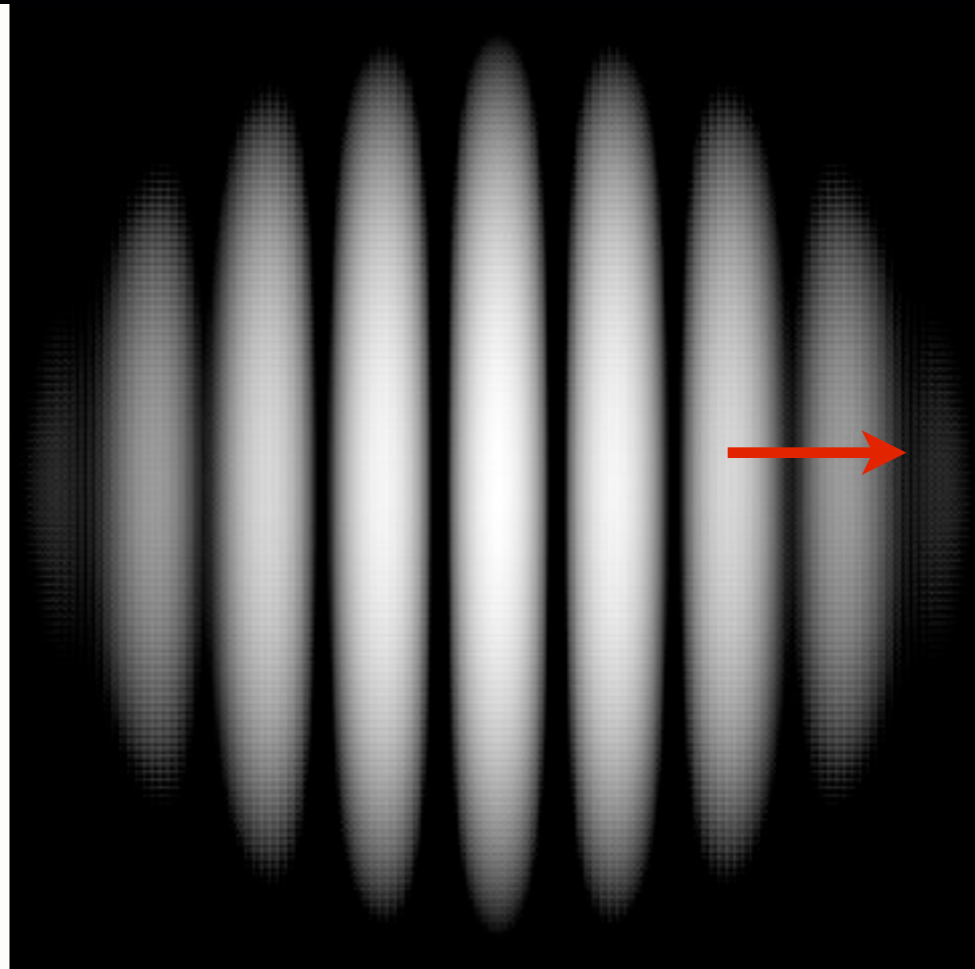
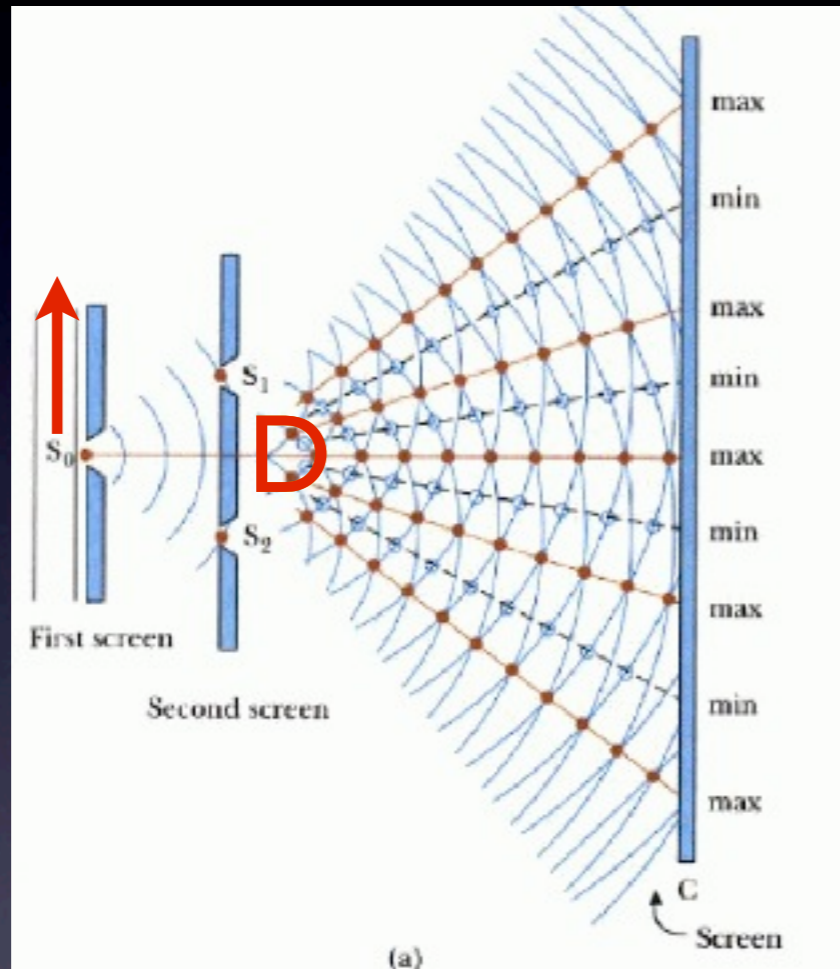

# Double slit experiment

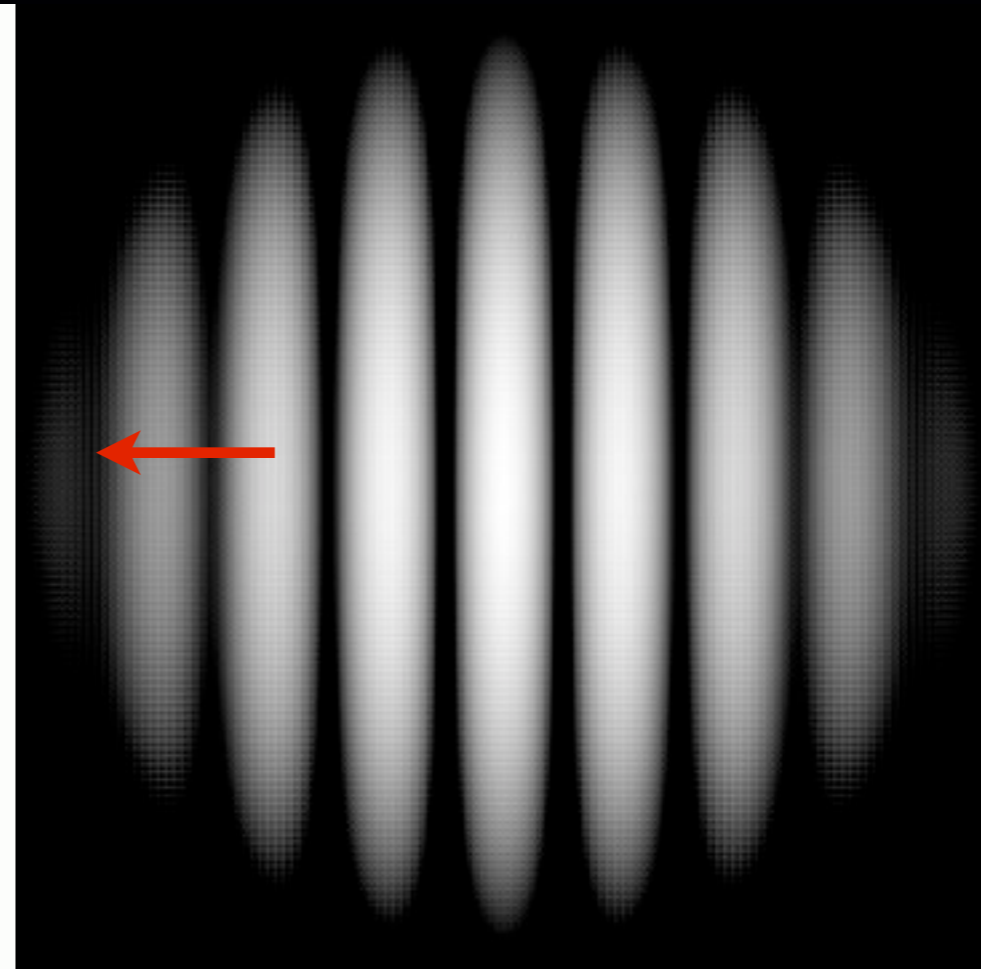
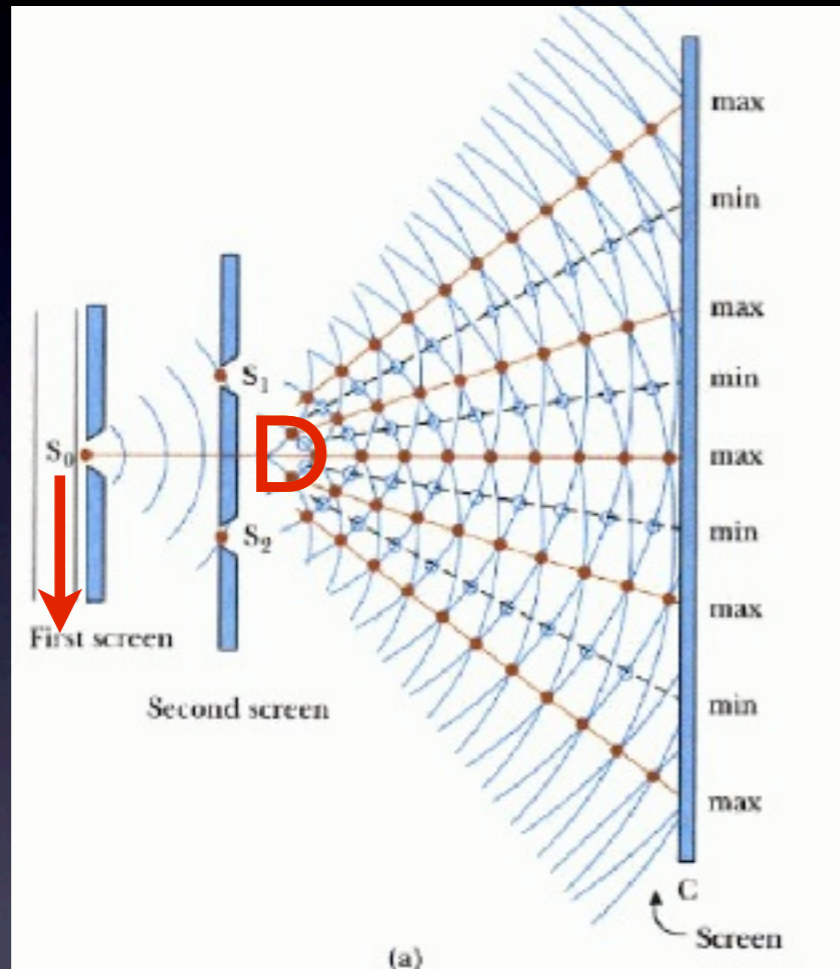

# Double slit experiment

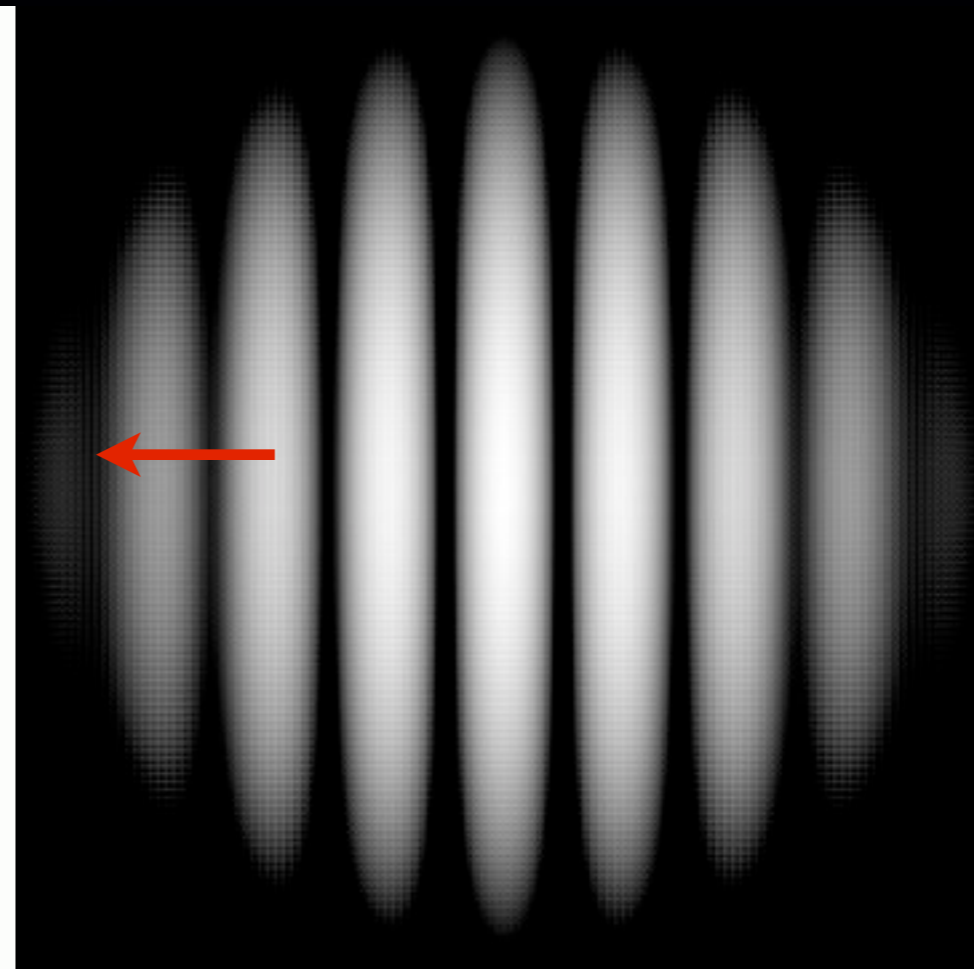
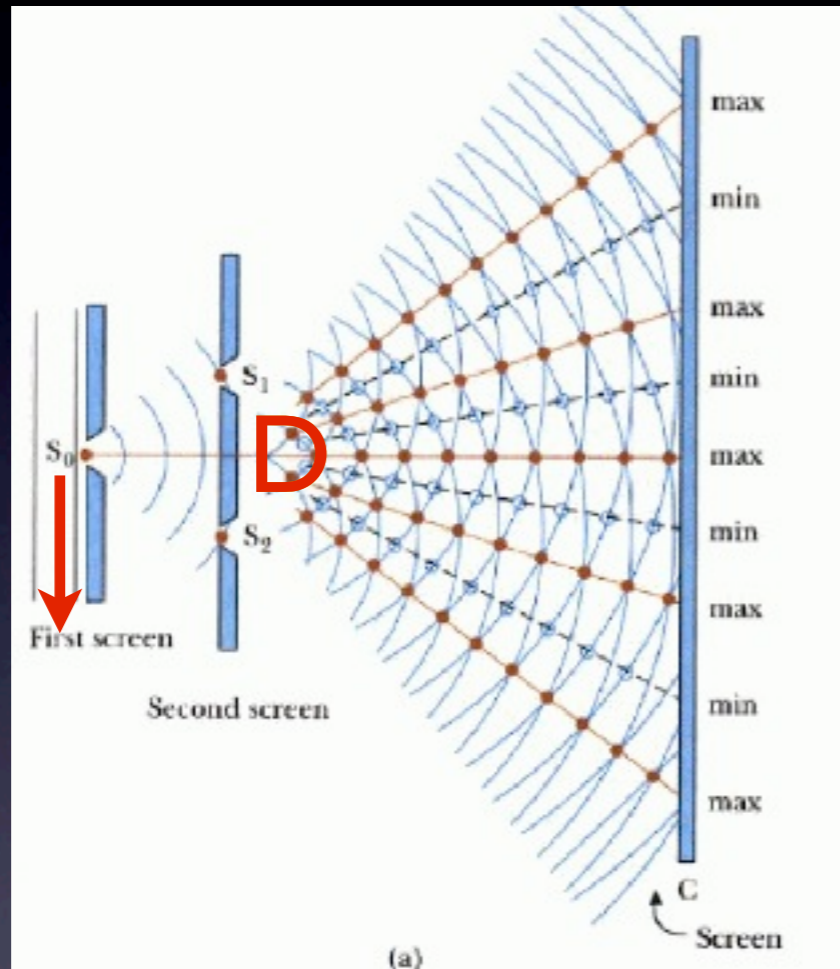

$$V = |V|e^{i\phi}$$

$$|V| = \frac{I_{max} - I_{min}}{I_{max} + I_{min}}$$

# Double slit experiment

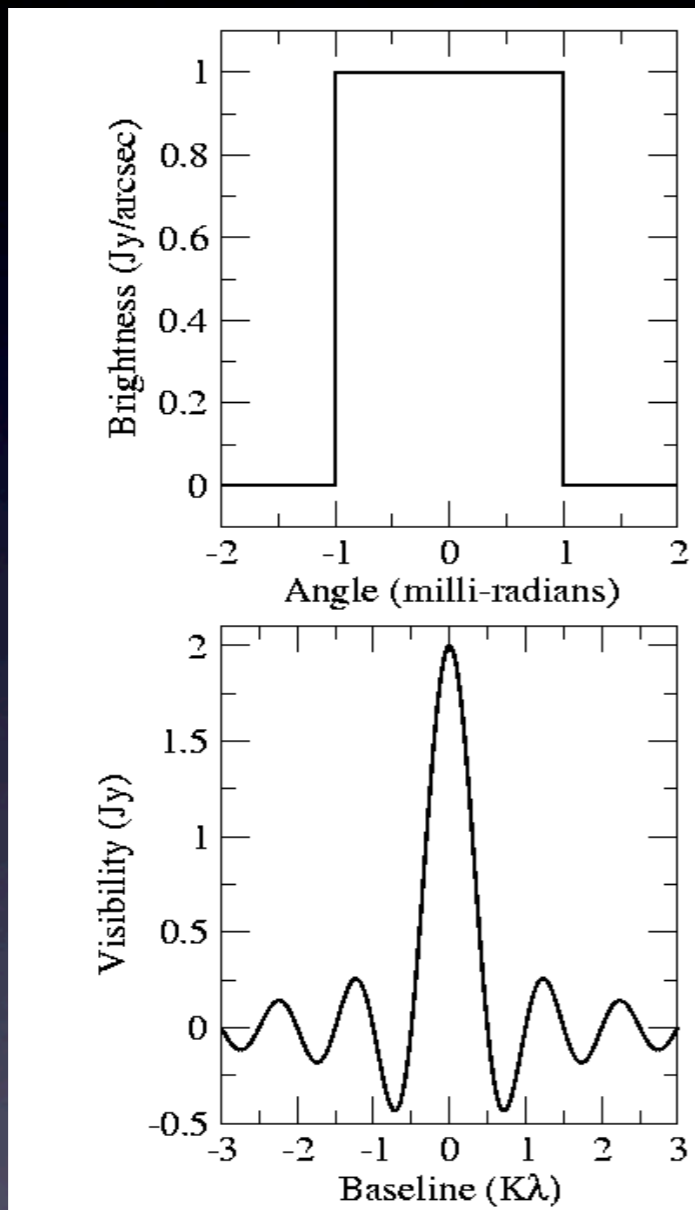

$$V = |V|e^{i\phi}$$

$$|V| = \frac{I_{max} - I_{min}}{I_{max} + I_{min}}$$

# Double slit experiment

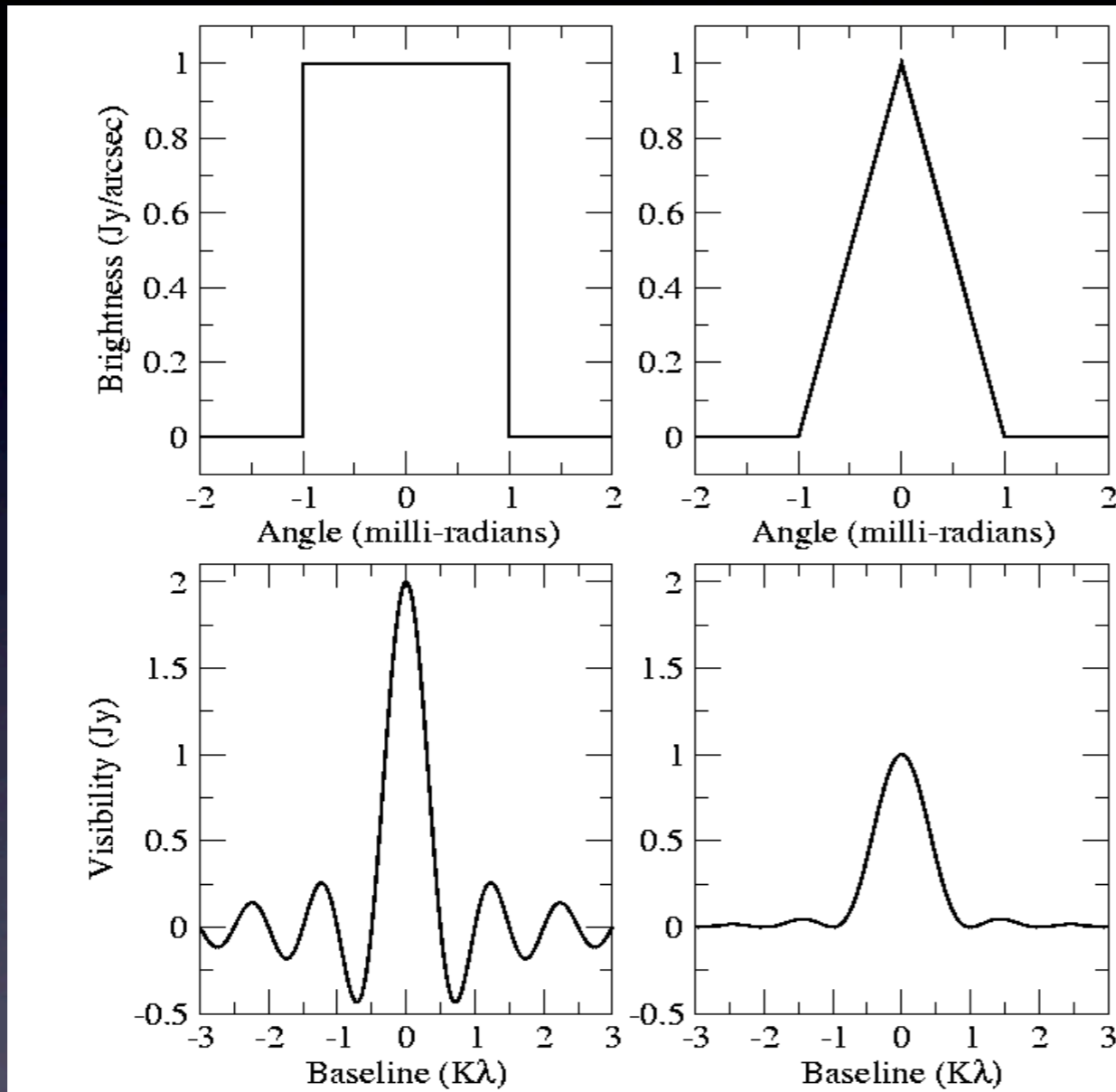

$$V = |V|e^{i\phi}$$

$$|V| = \frac{I_{max} - I_{min}}{I_{max} + I_{min}}$$

# Double slit experiment

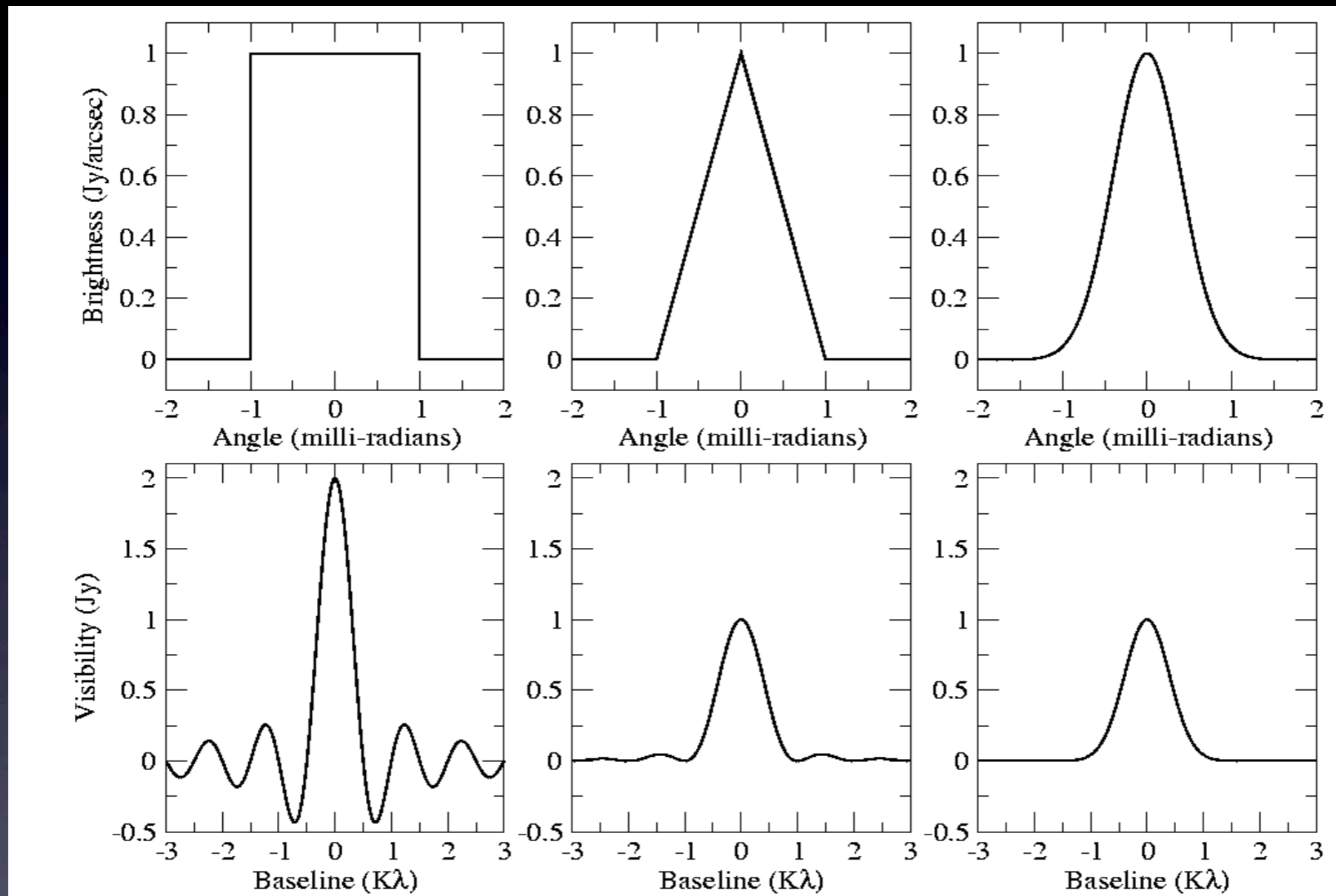

$$V = |V|e^{i\phi}$$

$$|V| = \frac{I_{max} - I_{min}}{I_{max} + I_{min}}$$



# Double slit experiment

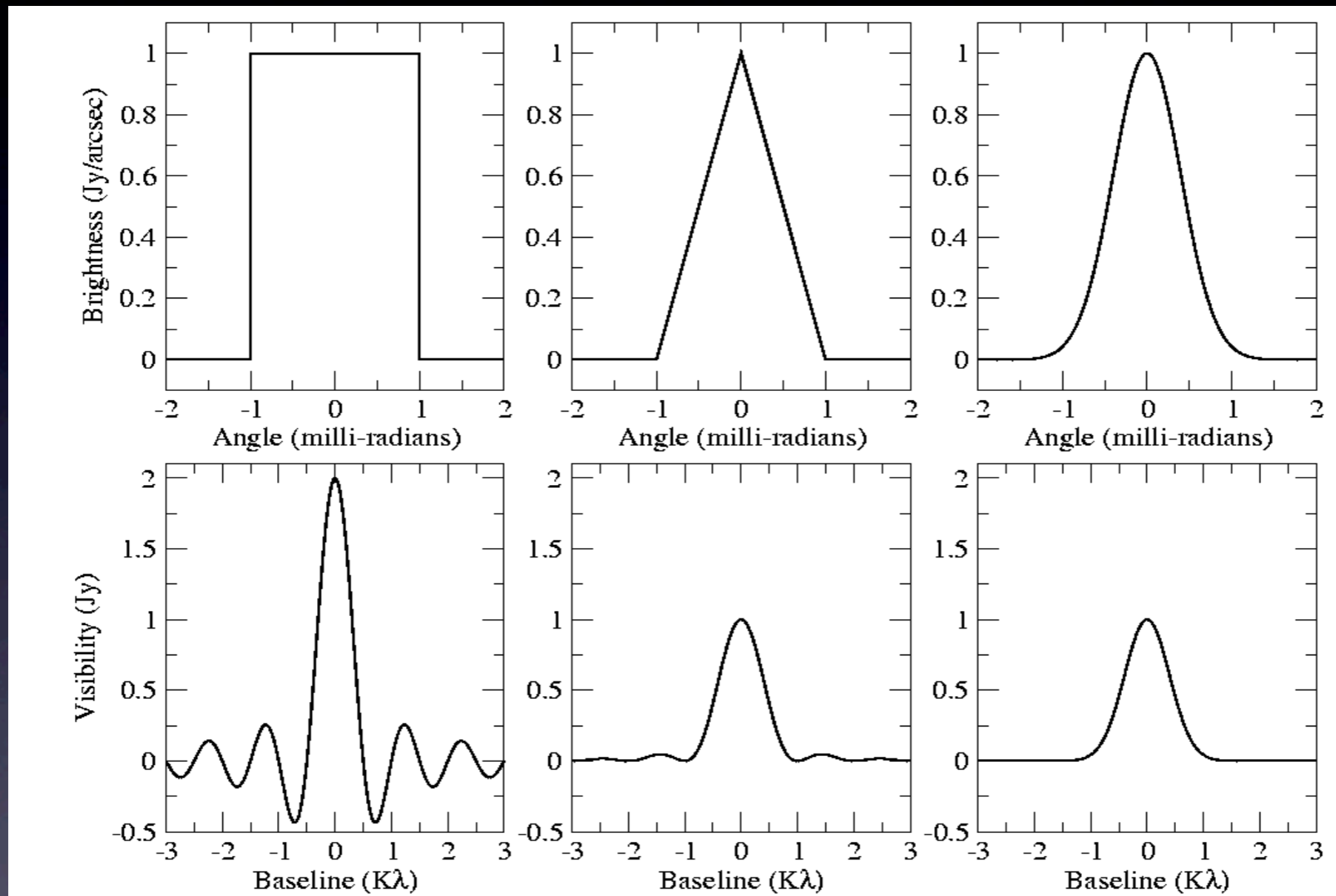

FT!!

$$V = |V|e^{i\phi}$$

$$|V| = \frac{I_{max} - I_{min}}{I_{max} + I_{min}}$$

# Double slit experiment

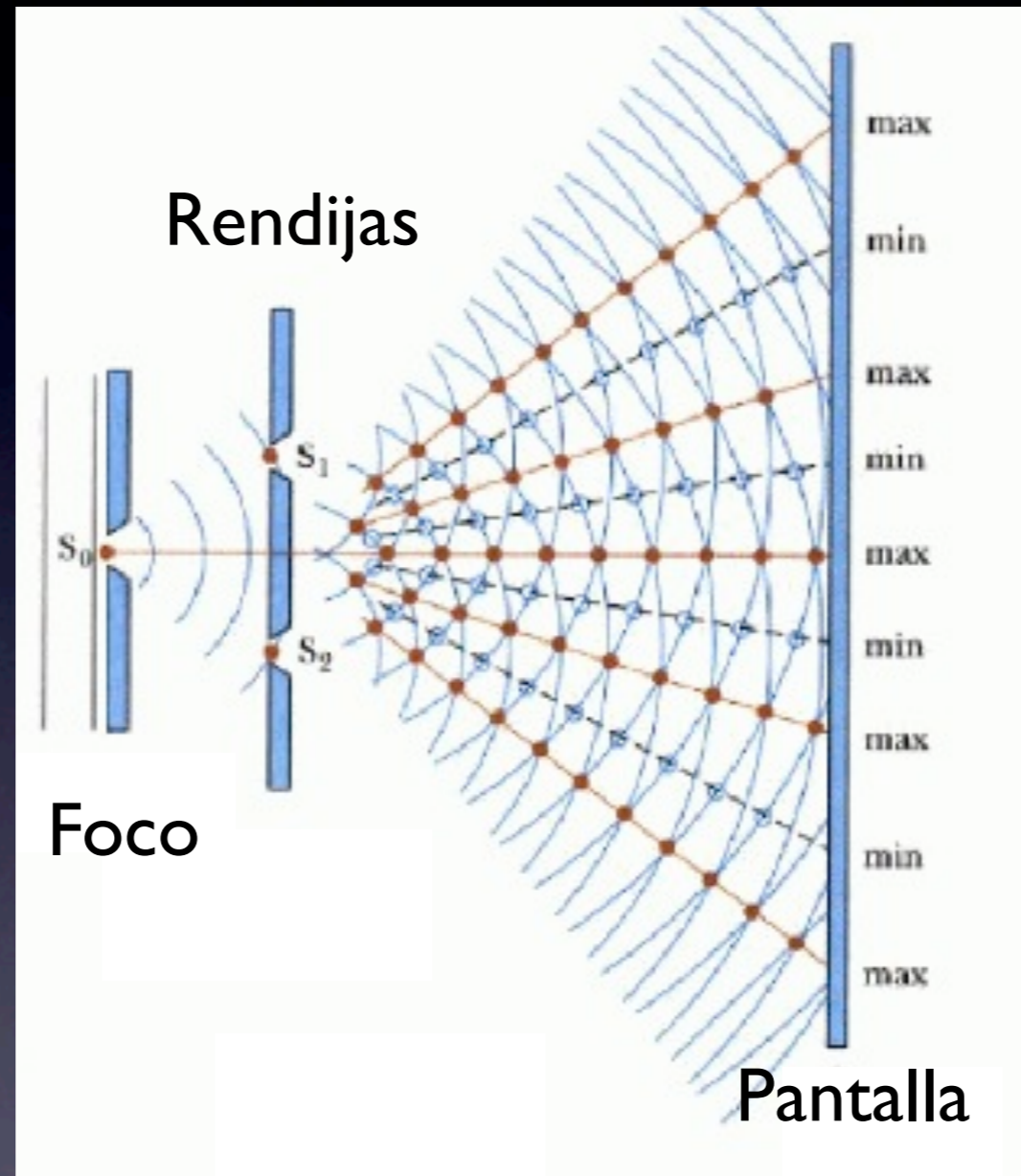

# Double slit experiment

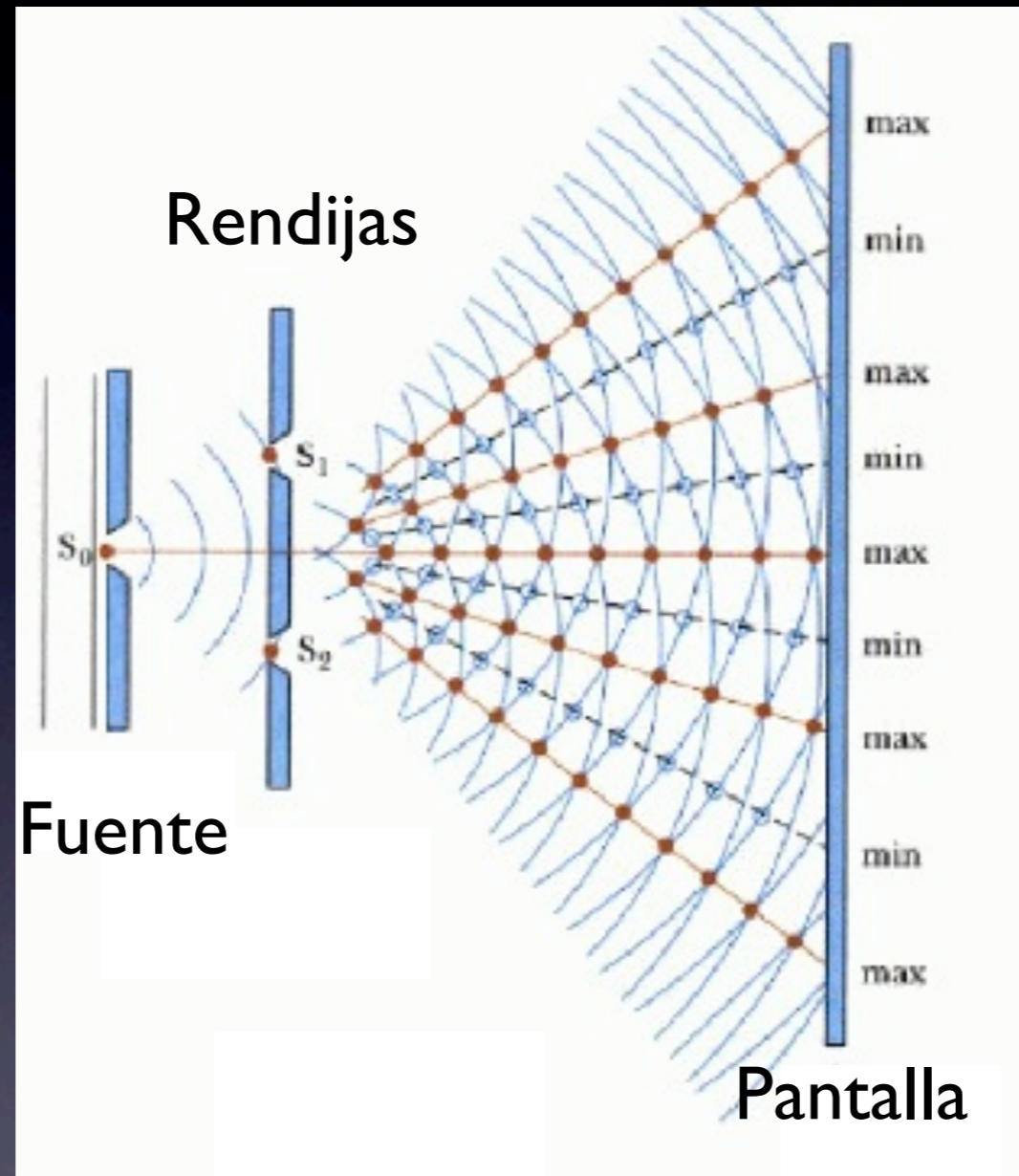

# Double slit experiment

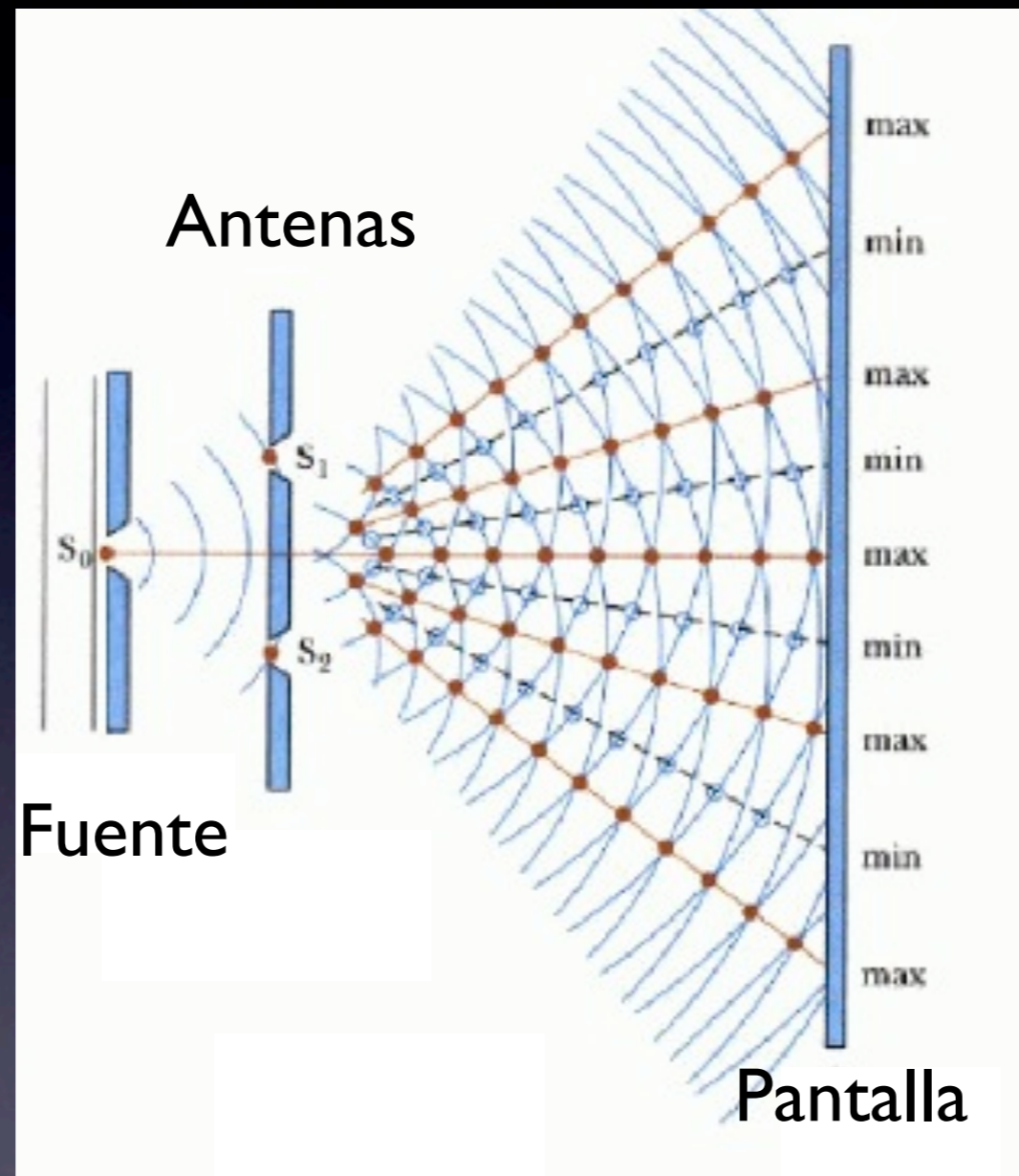

# Double slit experiment

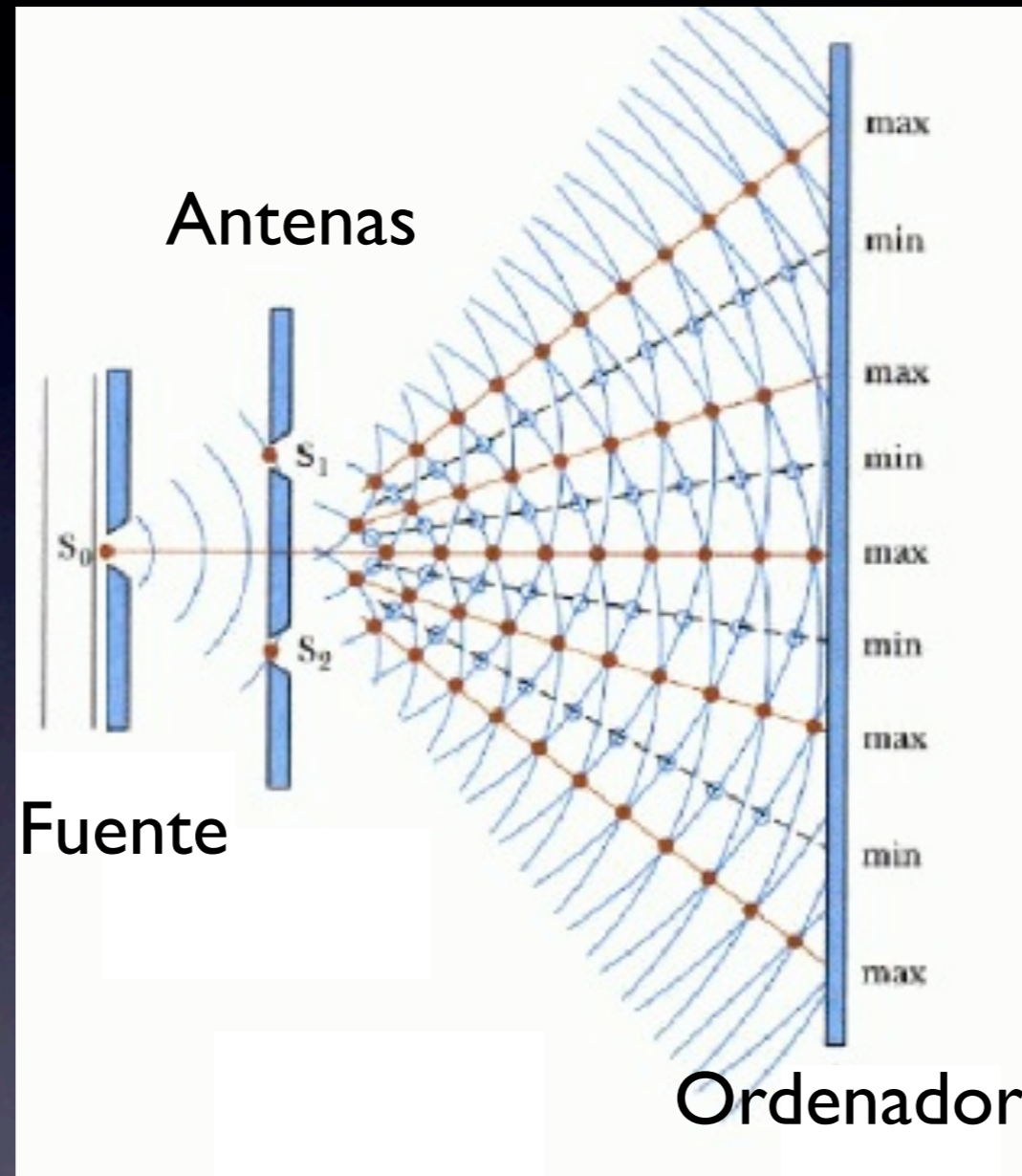

# Double slit experiment

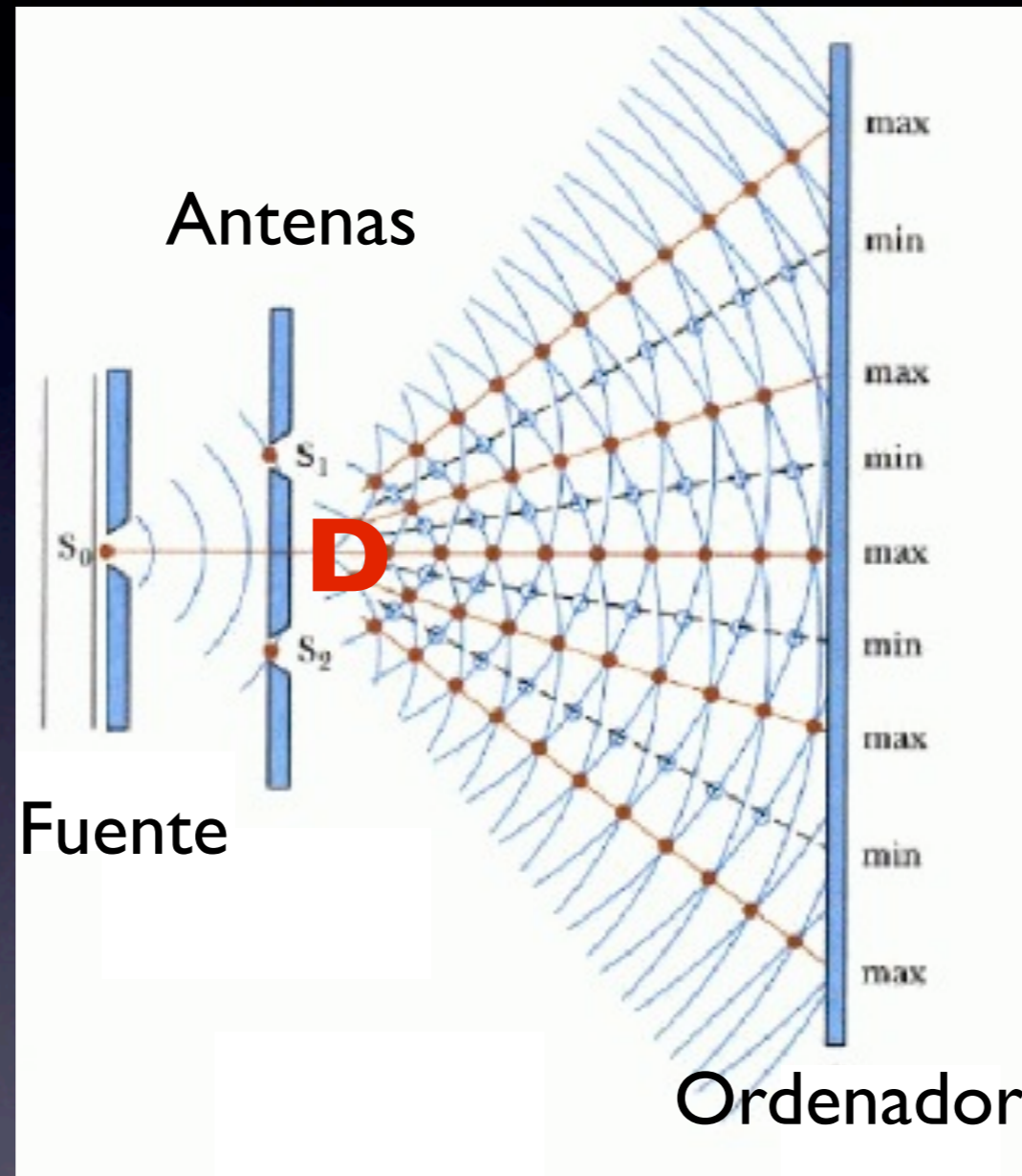

# u-v plane

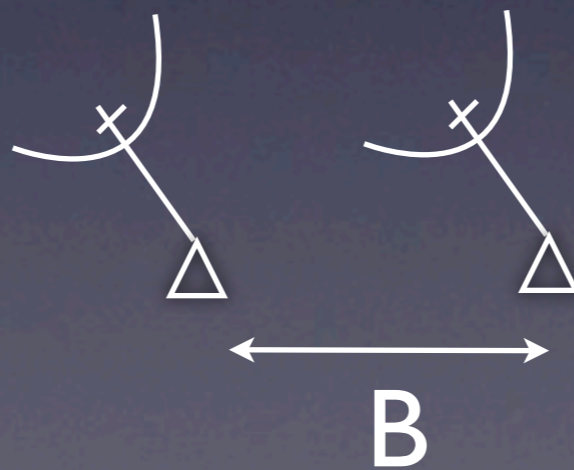

# u-v plane

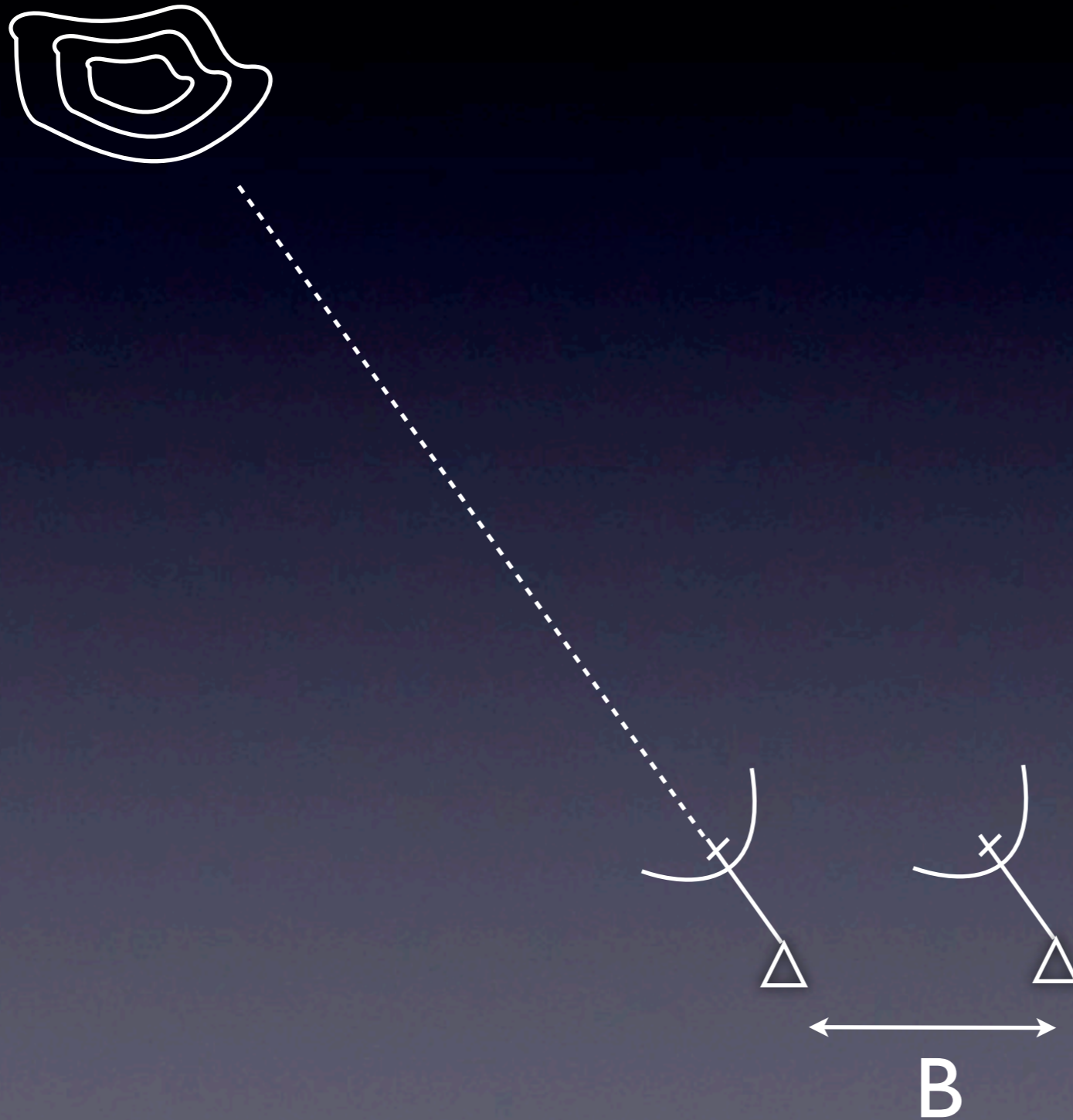



# u-v plane

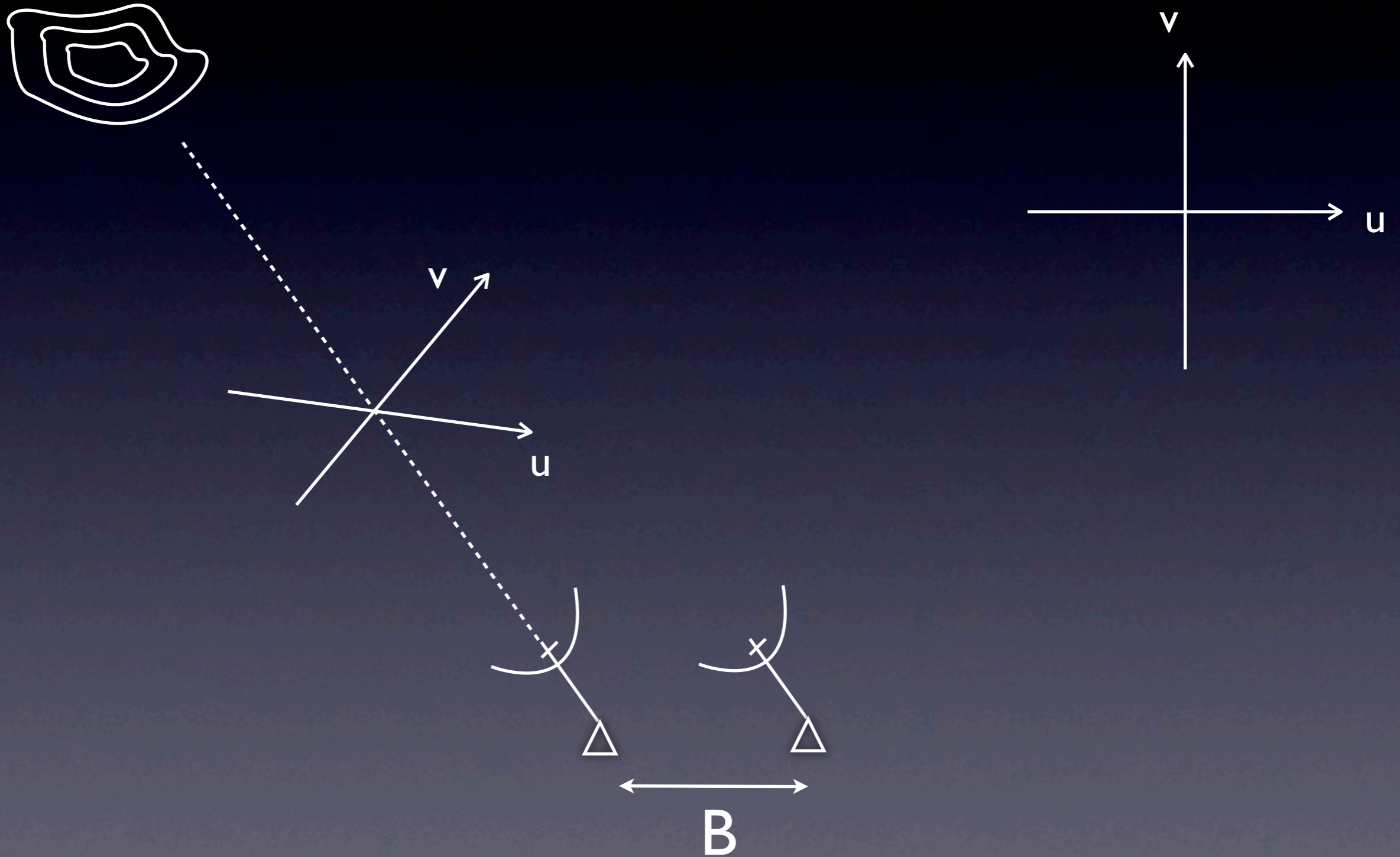

# u-v plane

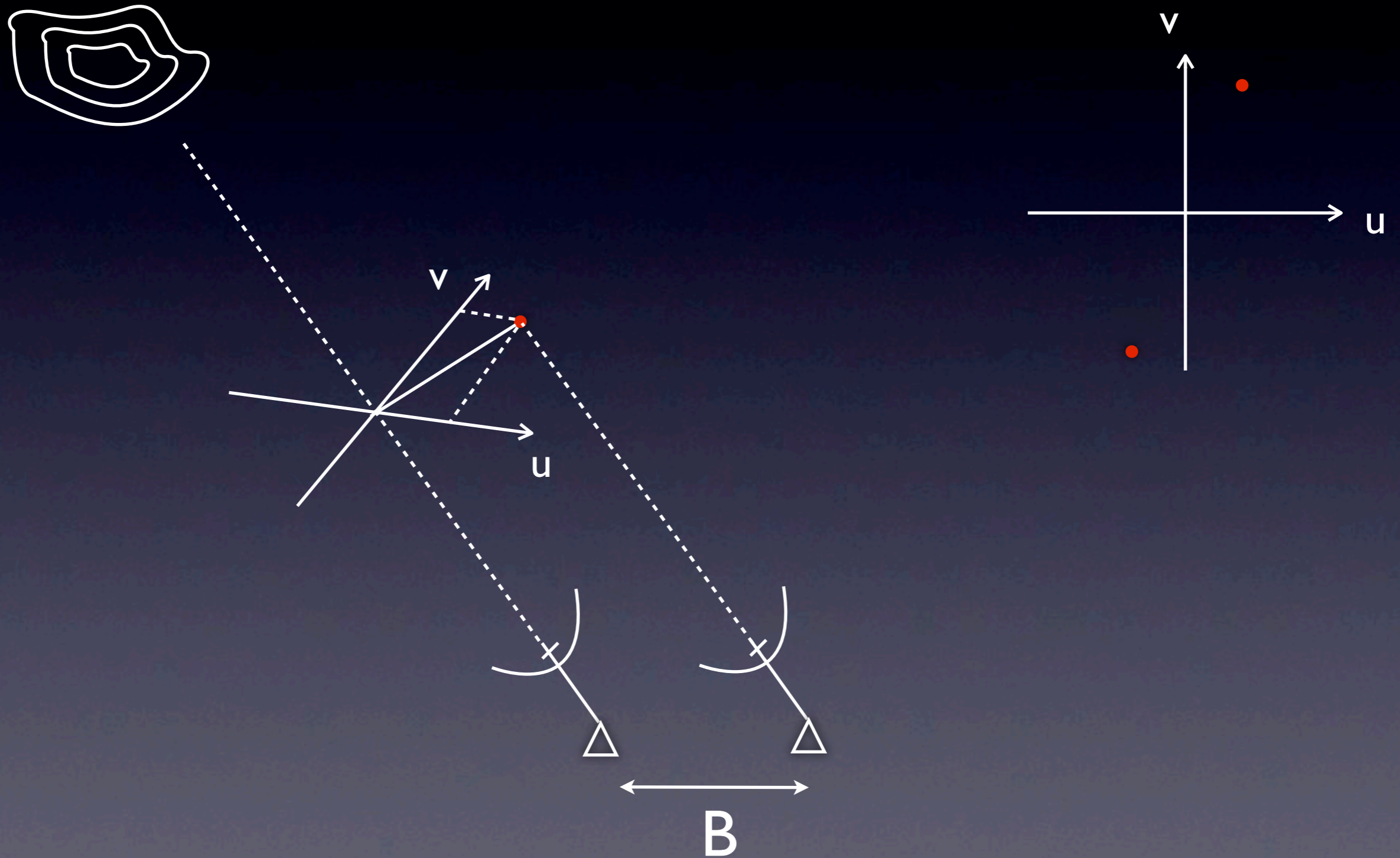

# u-v plane

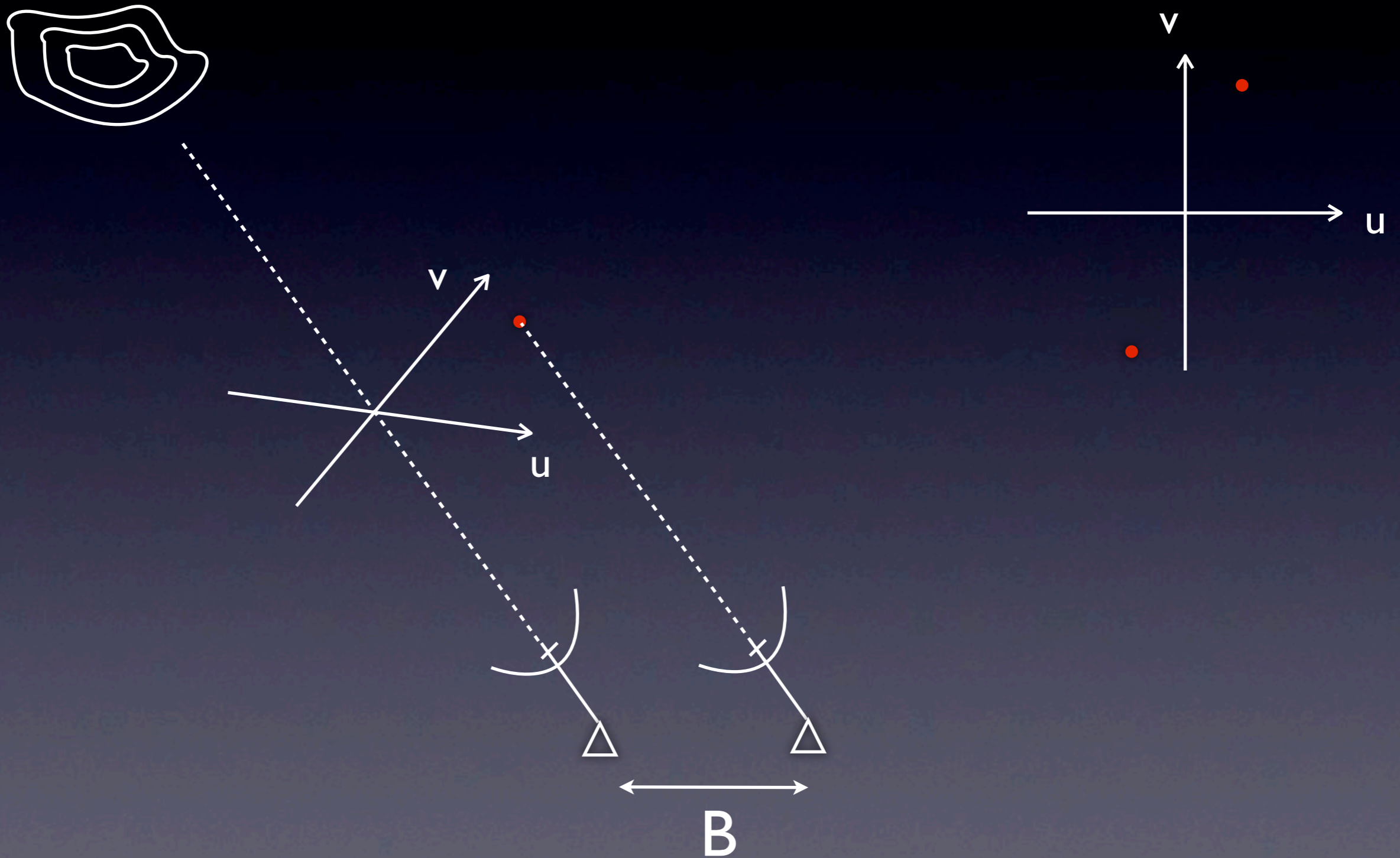

# u-v plane

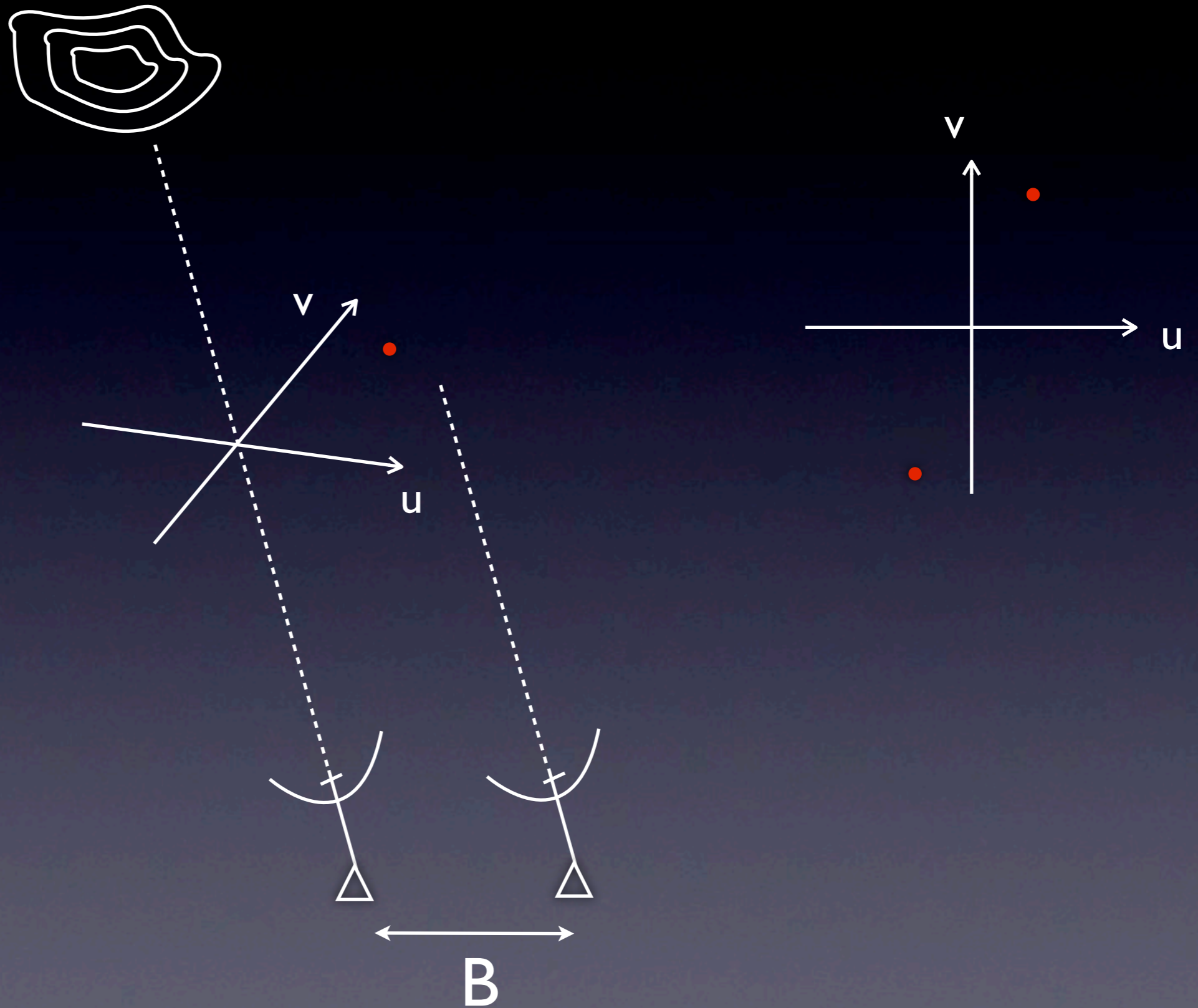

# u-v plane

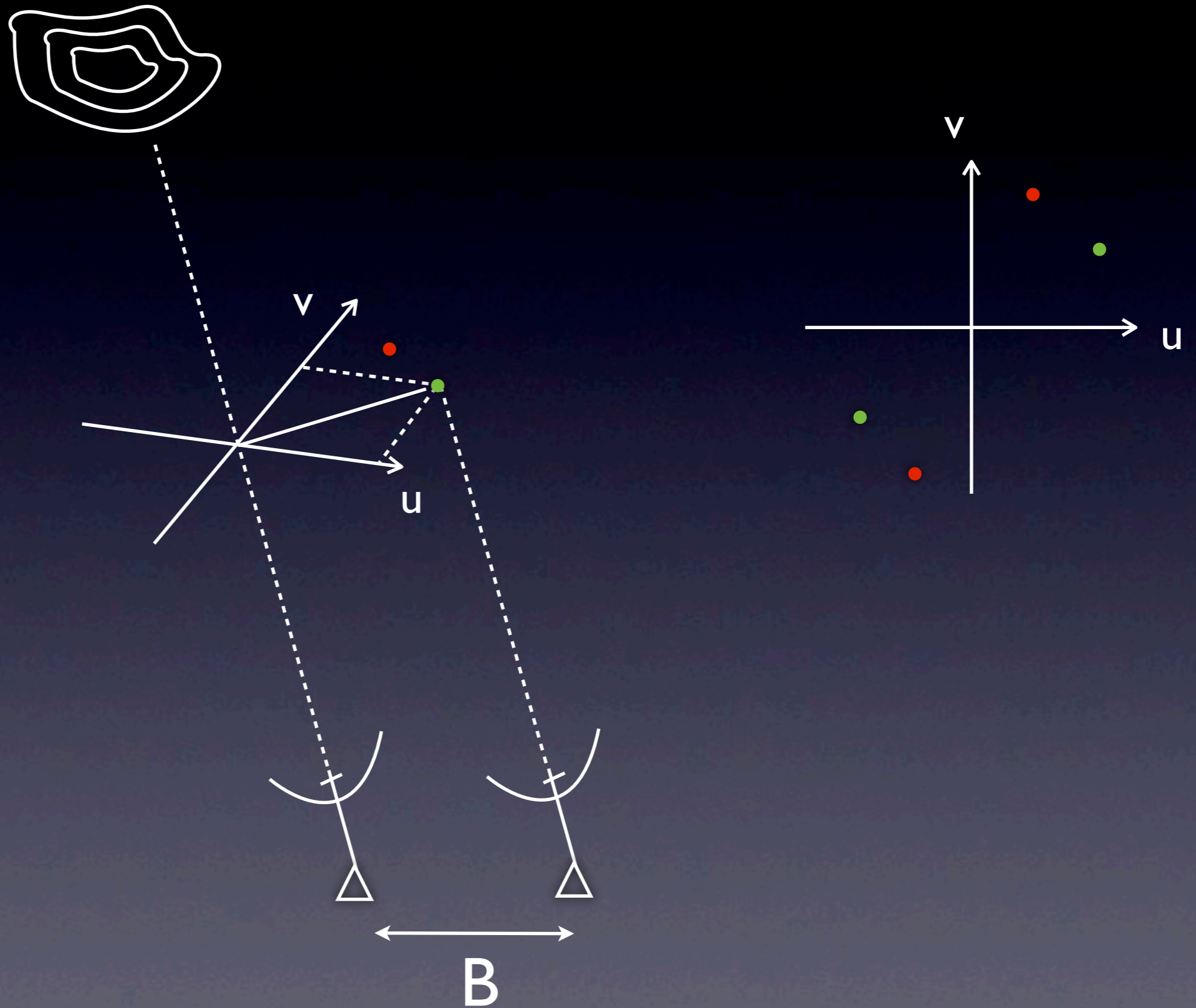

# u-v coverage: Dirty beam

2 antennas

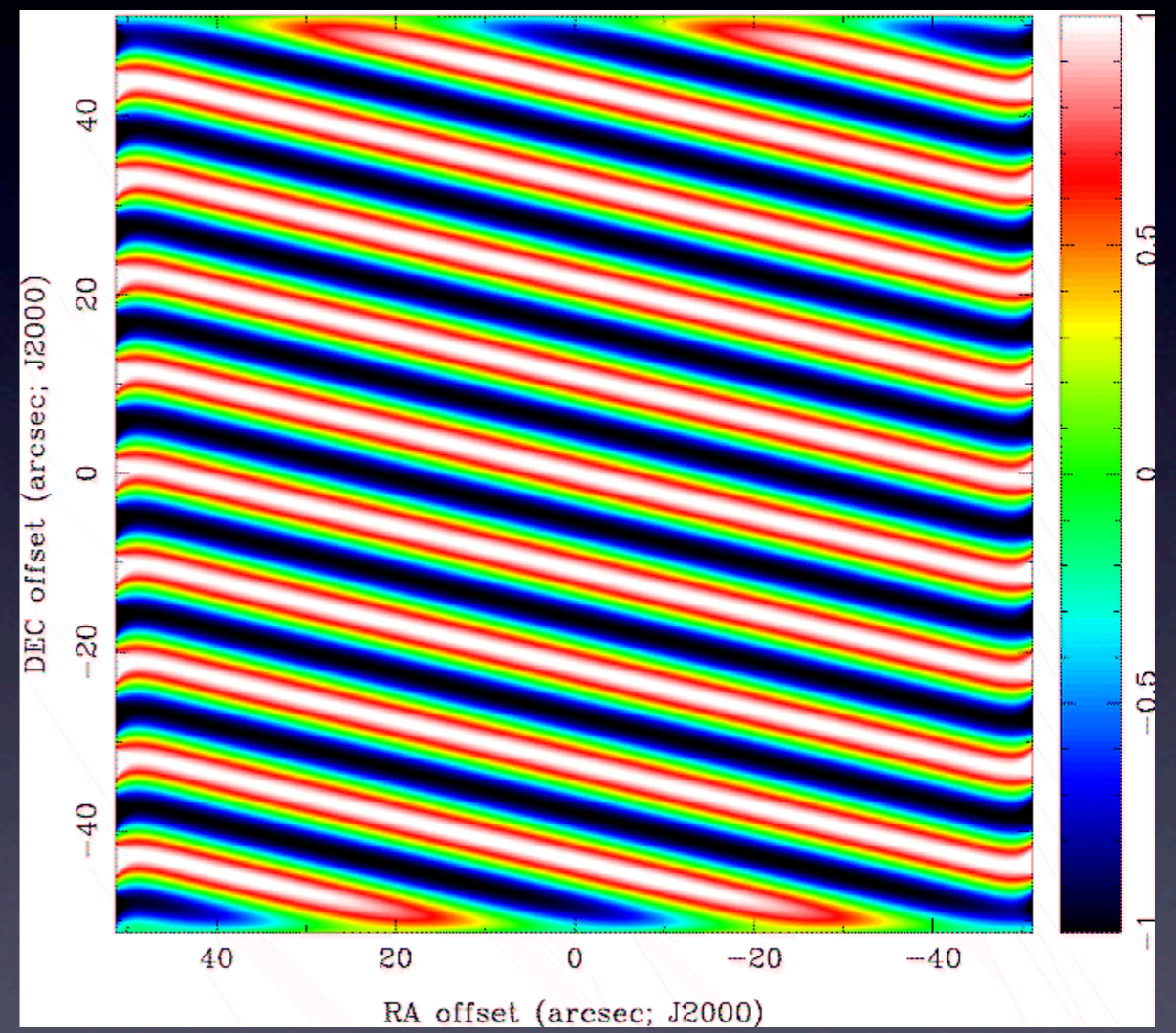
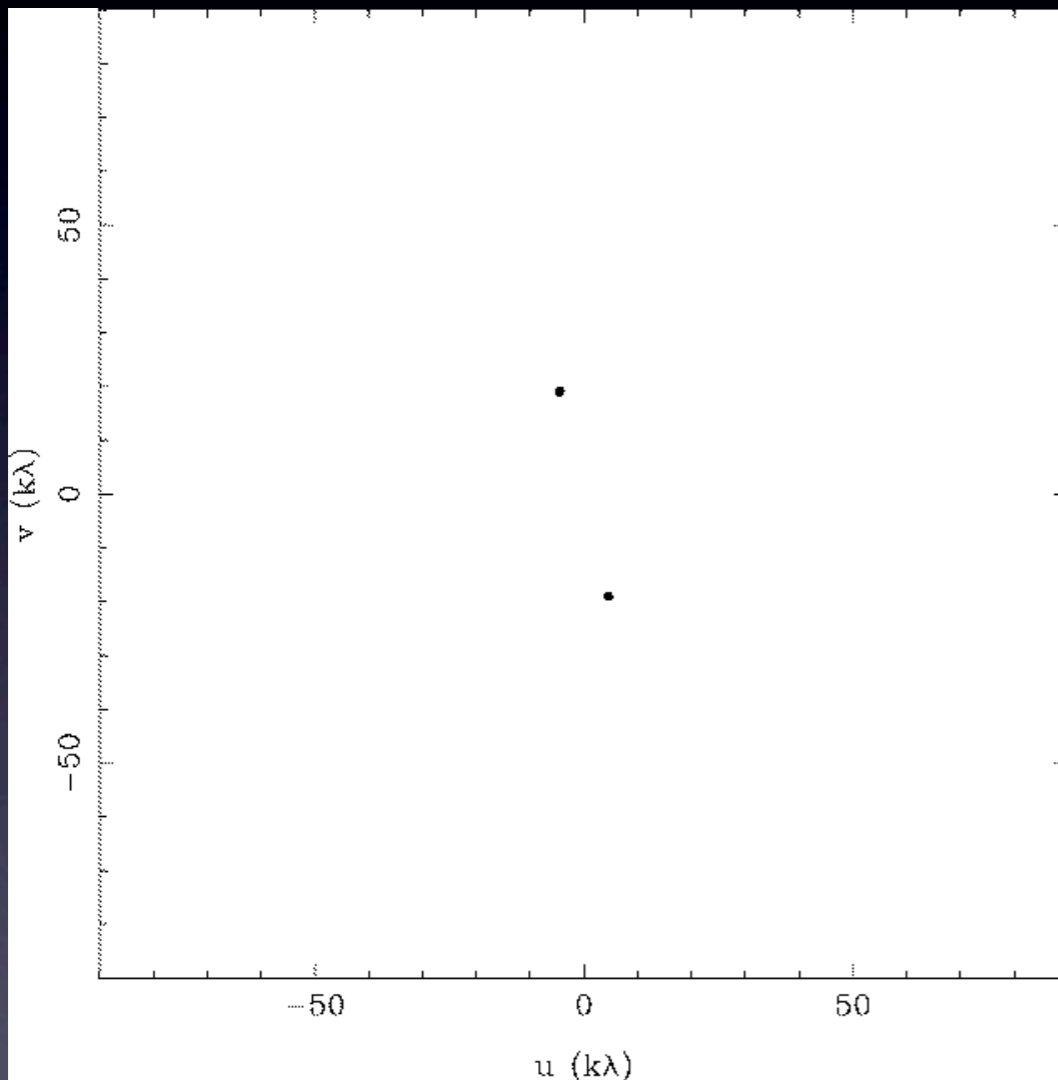

# u-v coverage: Dirty beam

3 antennas

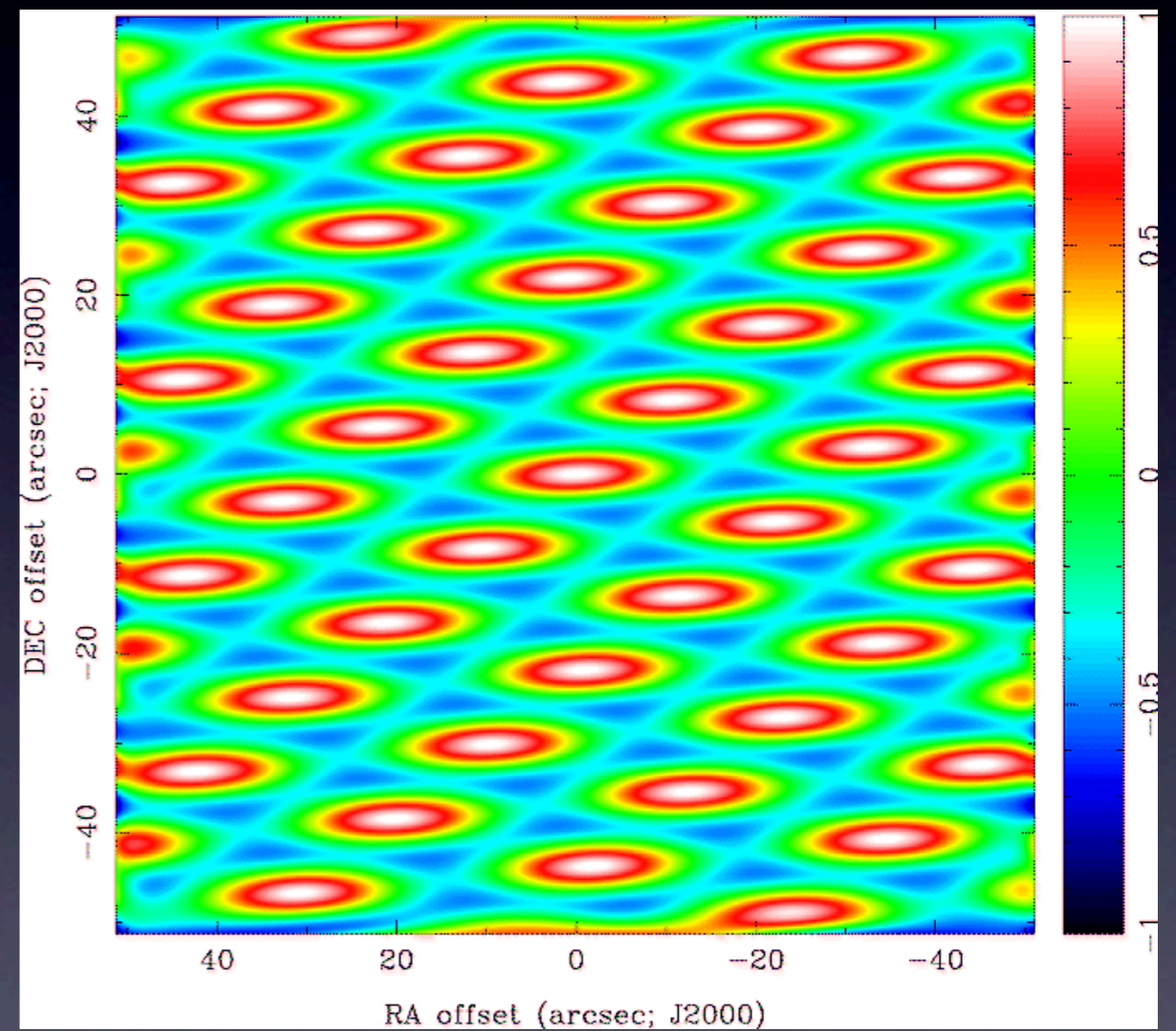
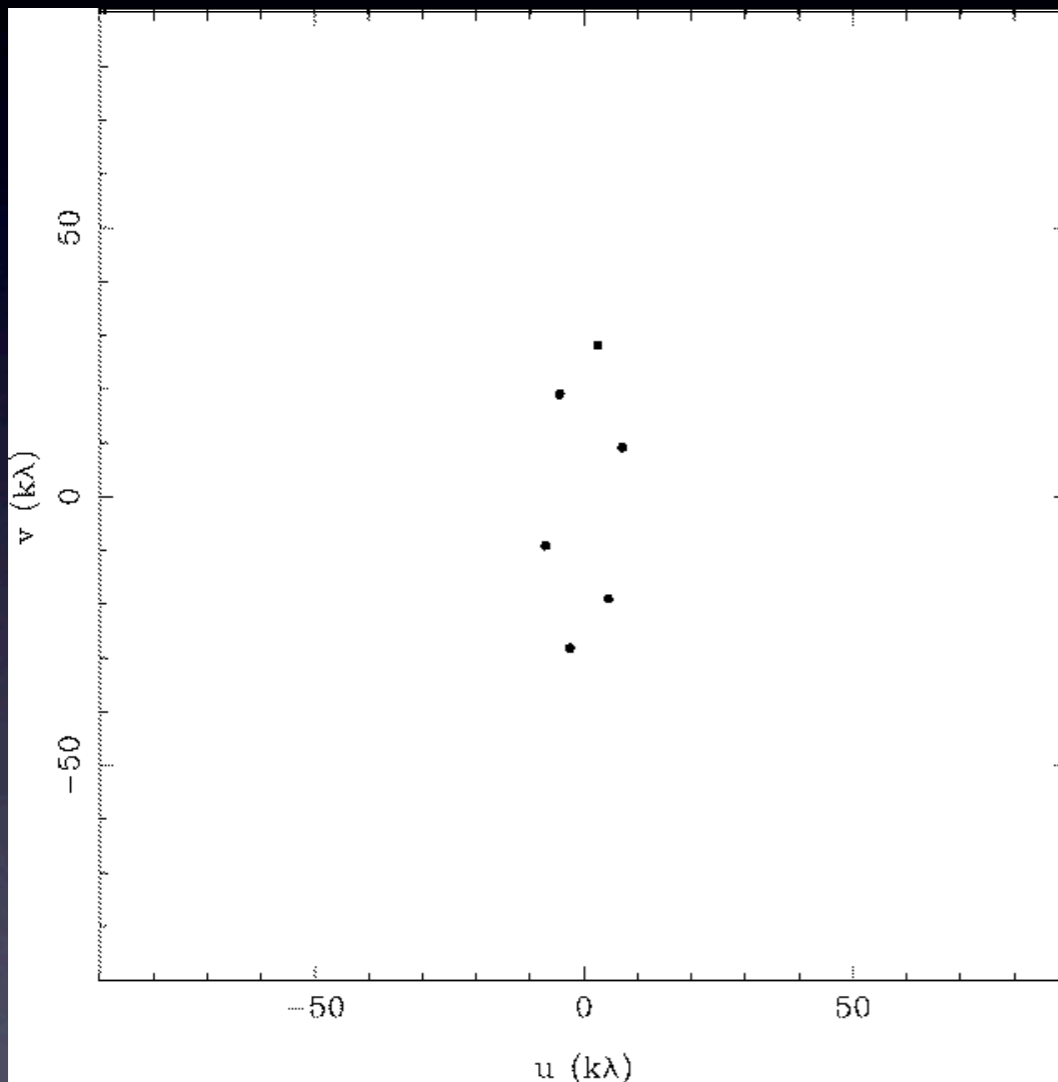

# u-v coverage: Dirty beam

4 antennas

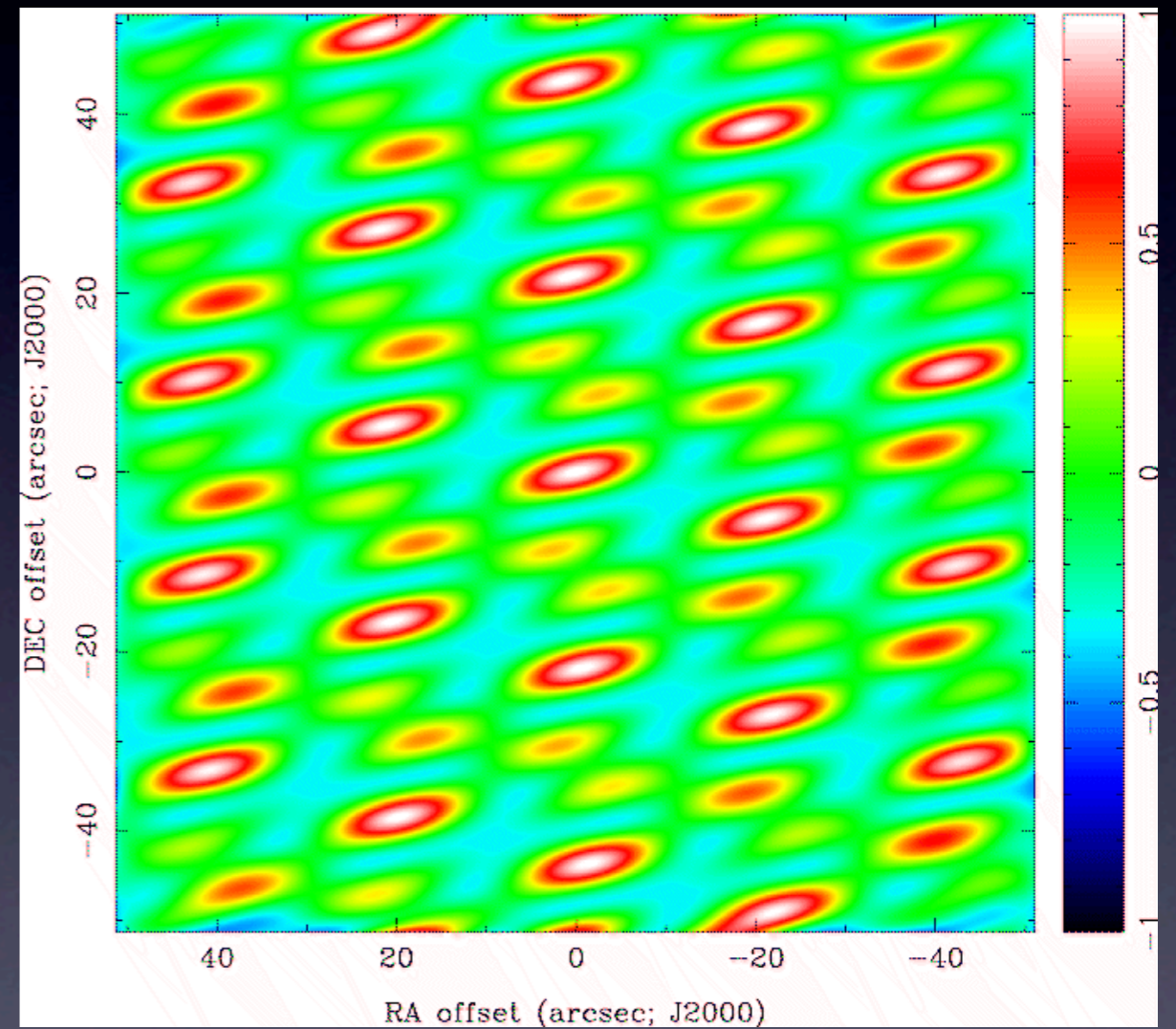
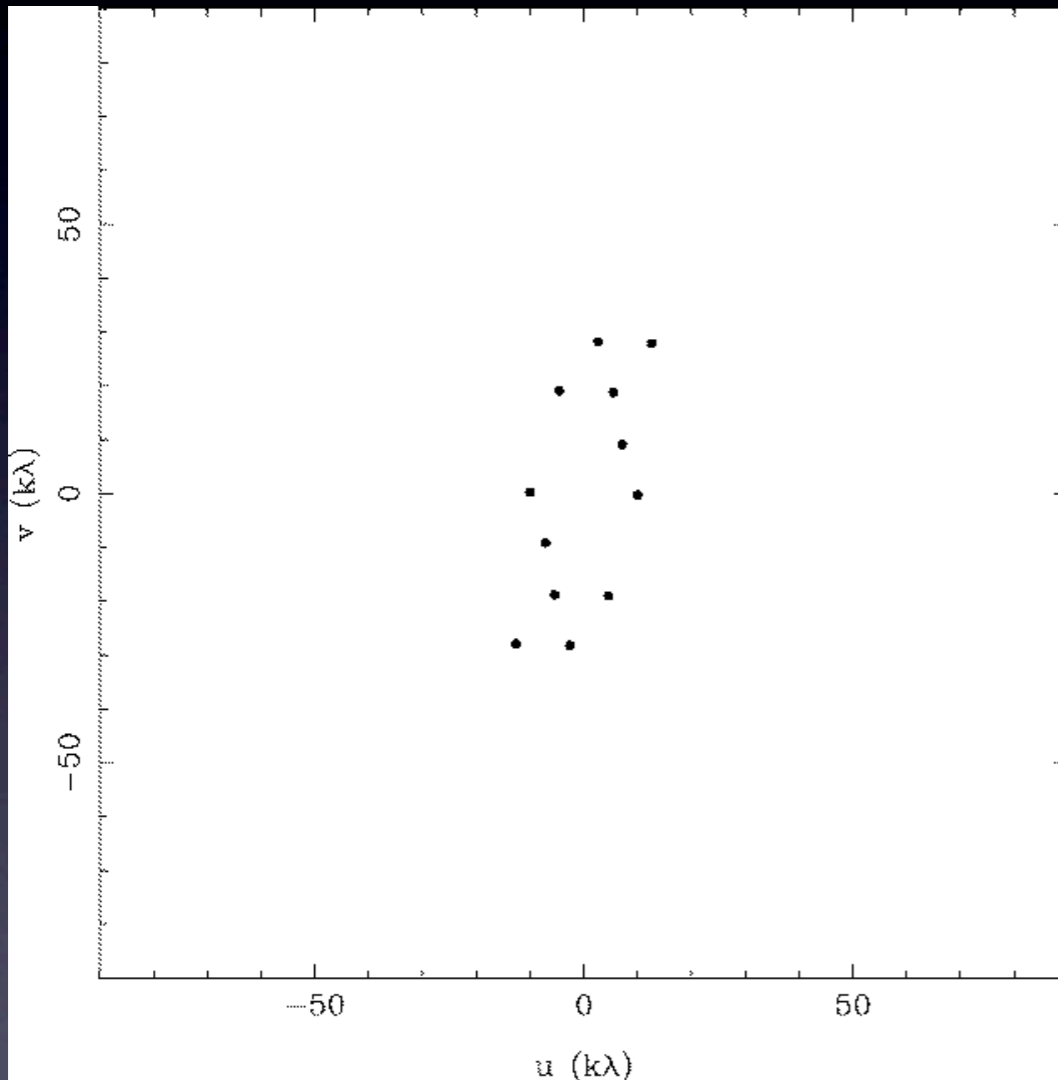



# u-v coverage: Dirty beam

5 antennas

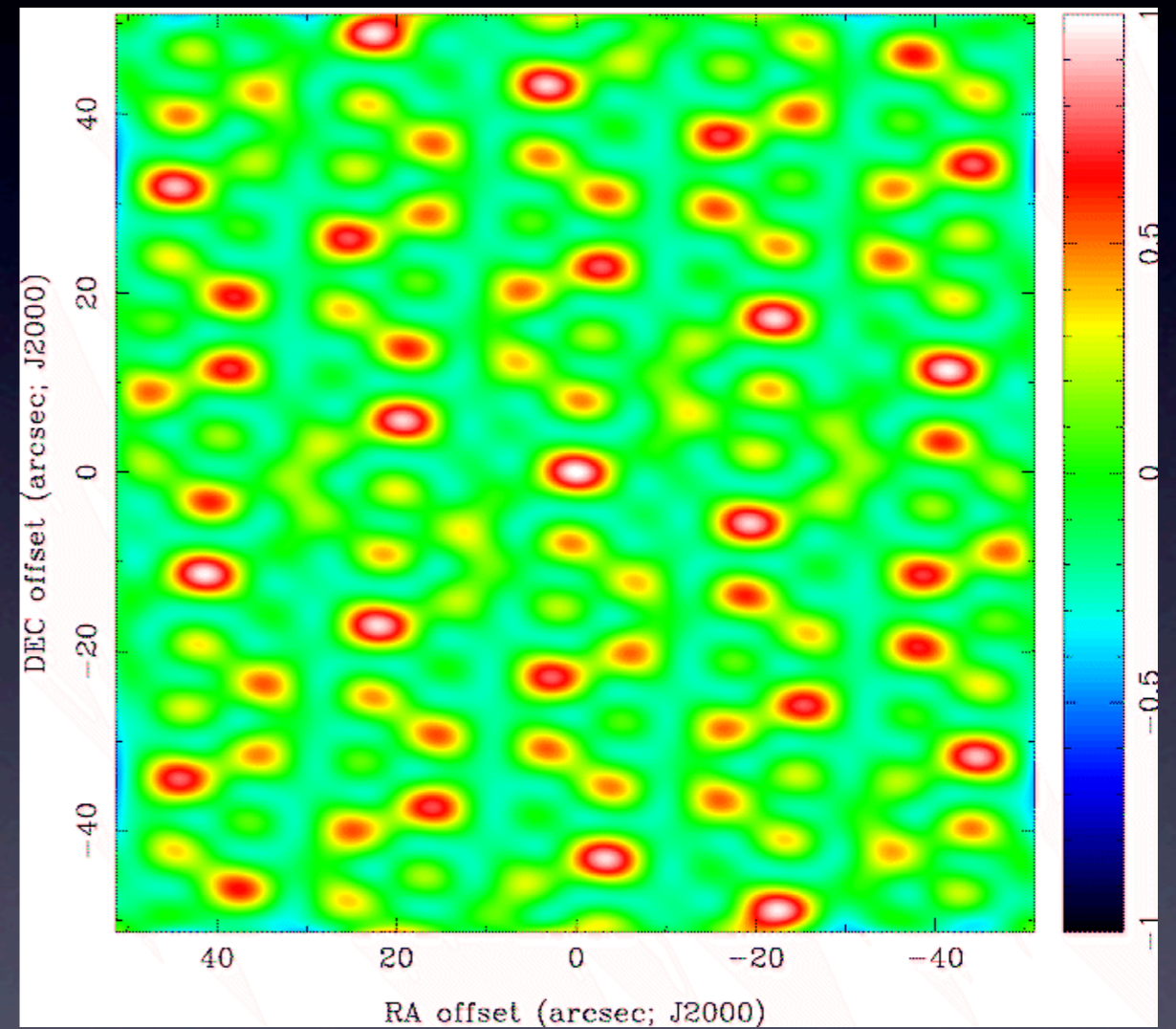
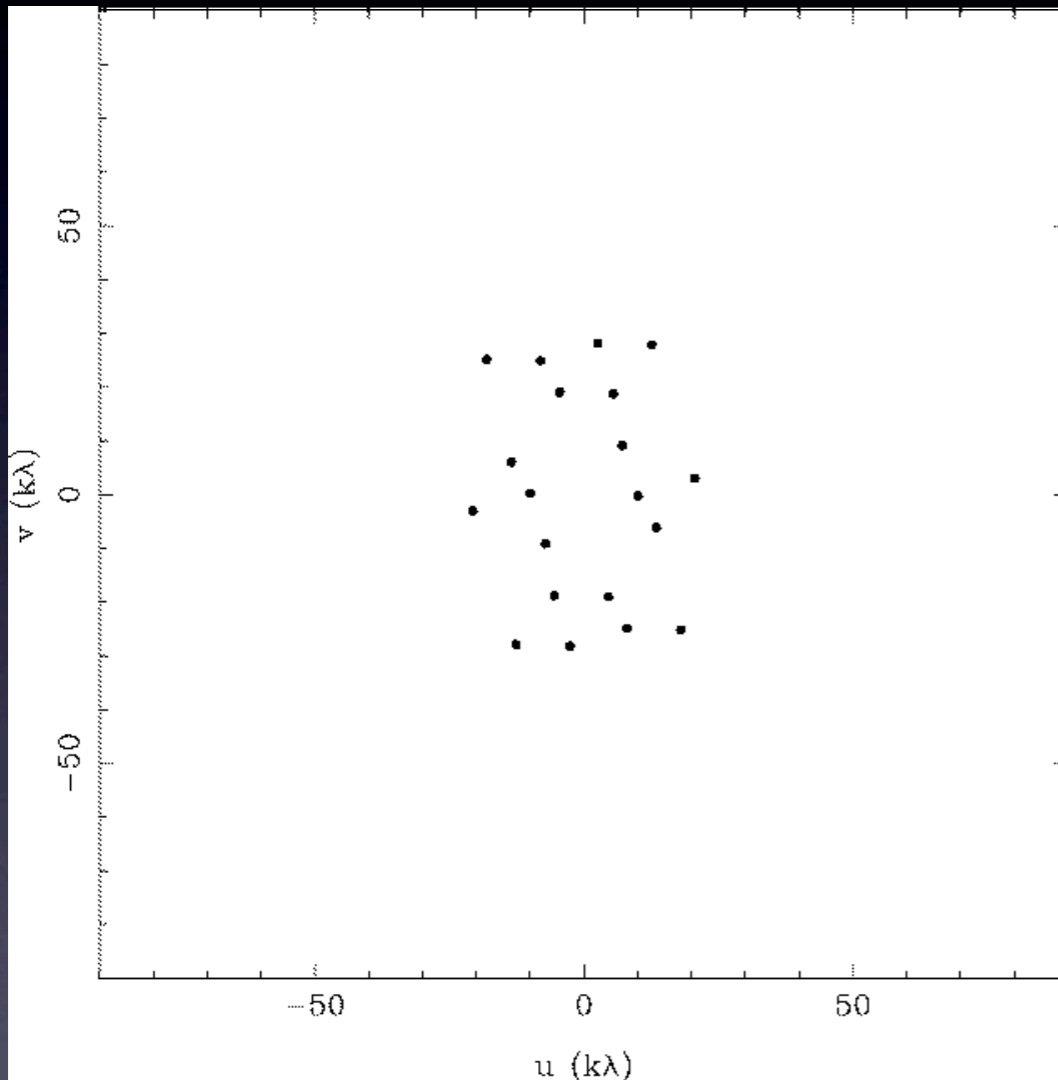

# u-v coverage: Dirty beam

6 antennas

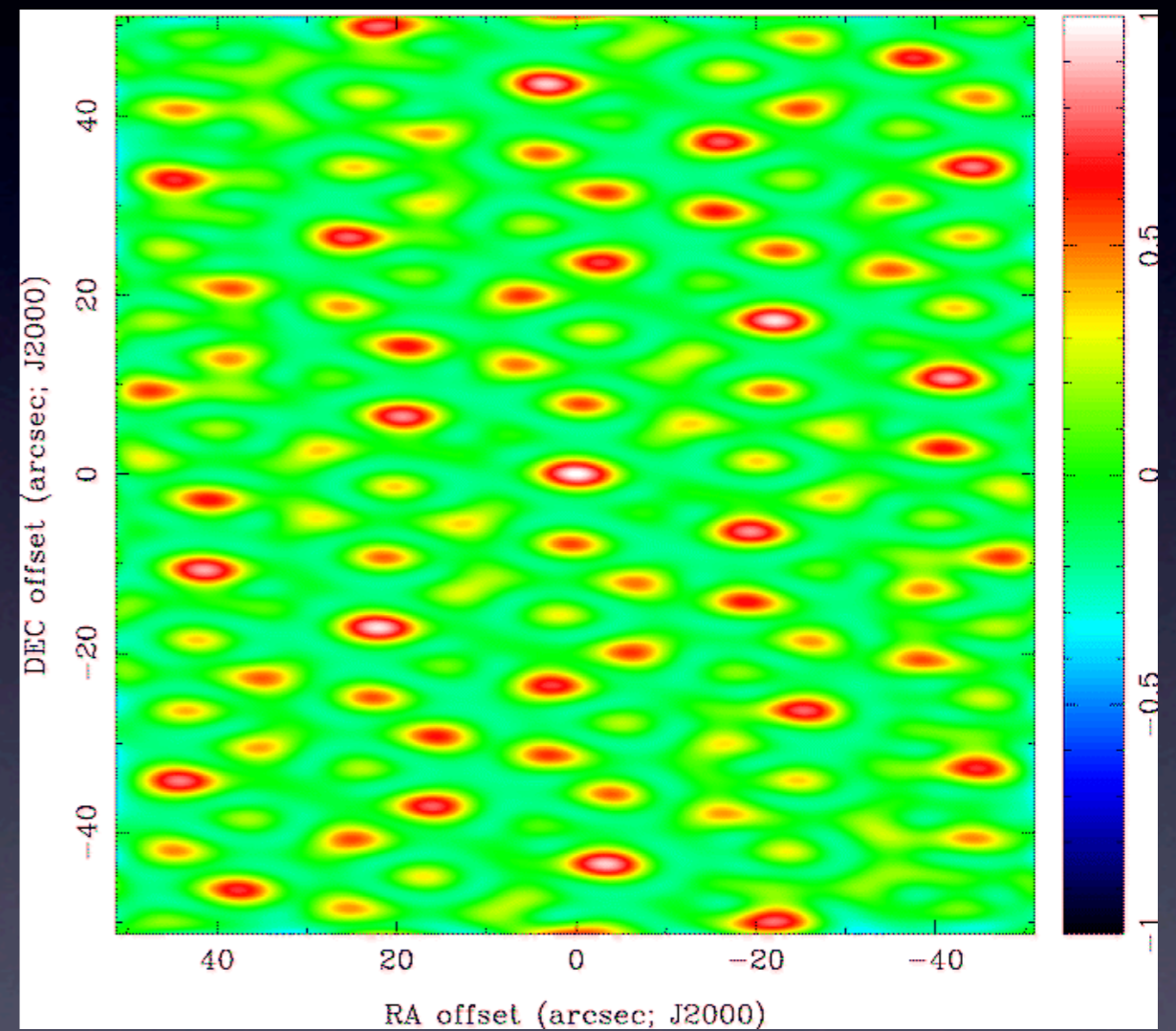
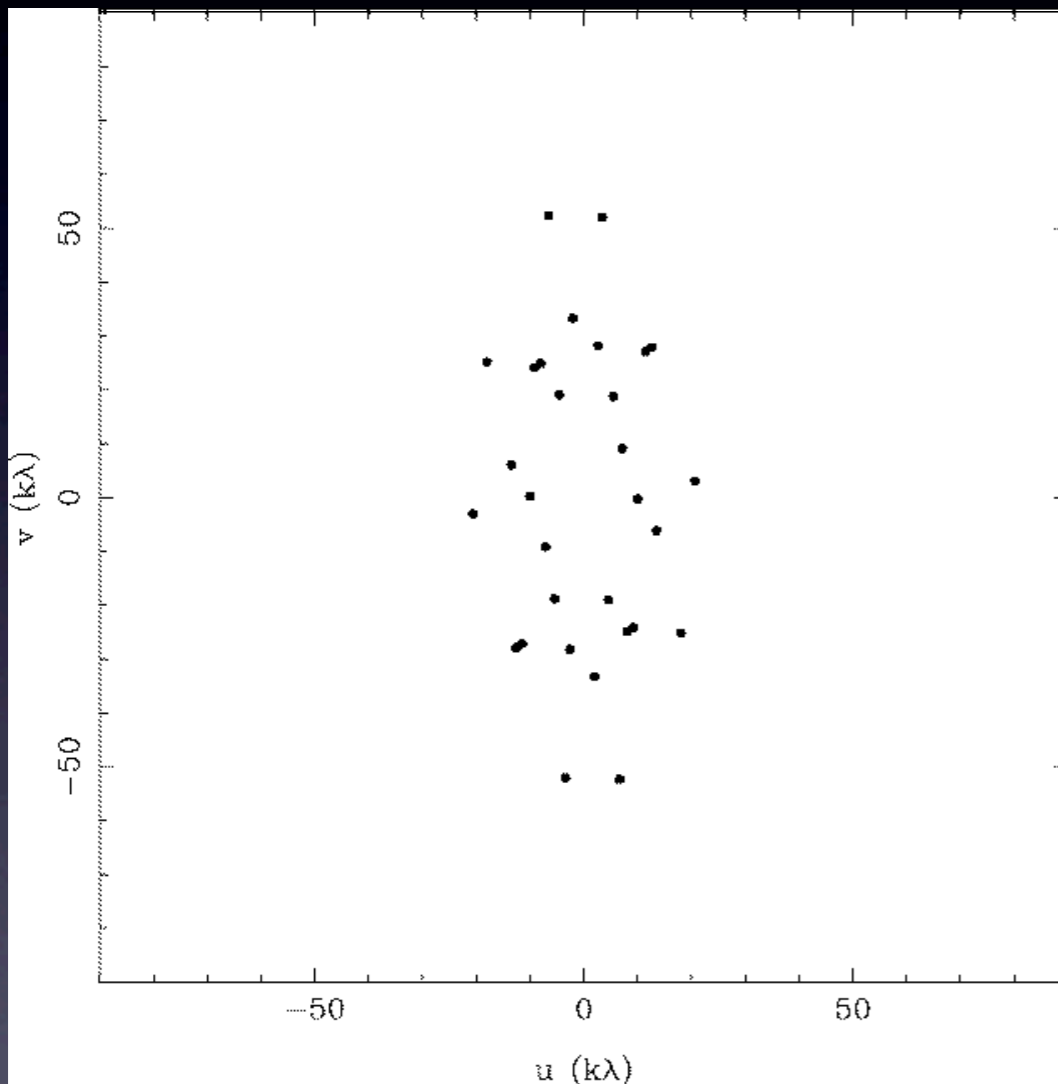

# u-v coverage: Dirty beam

7 antennas

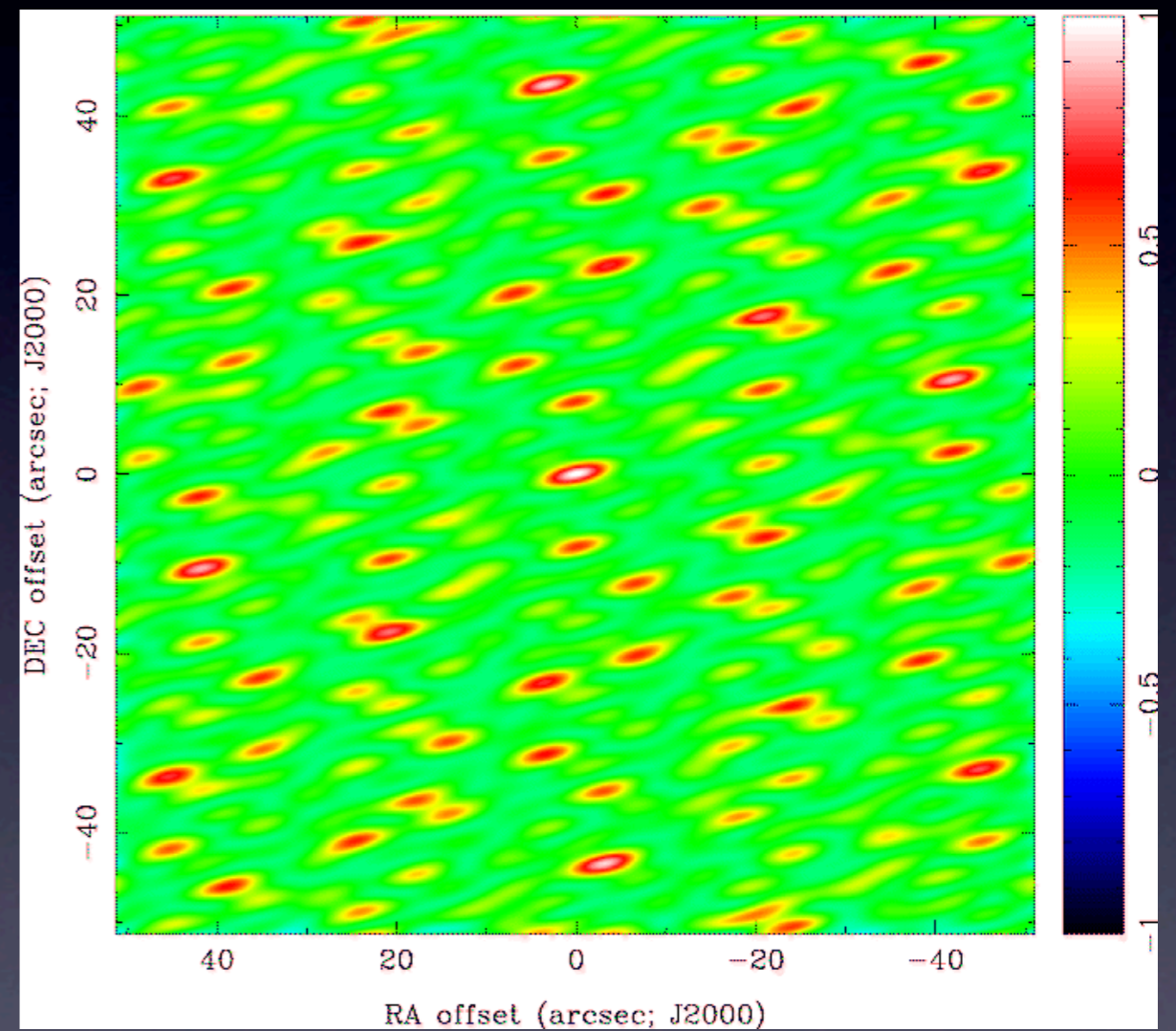
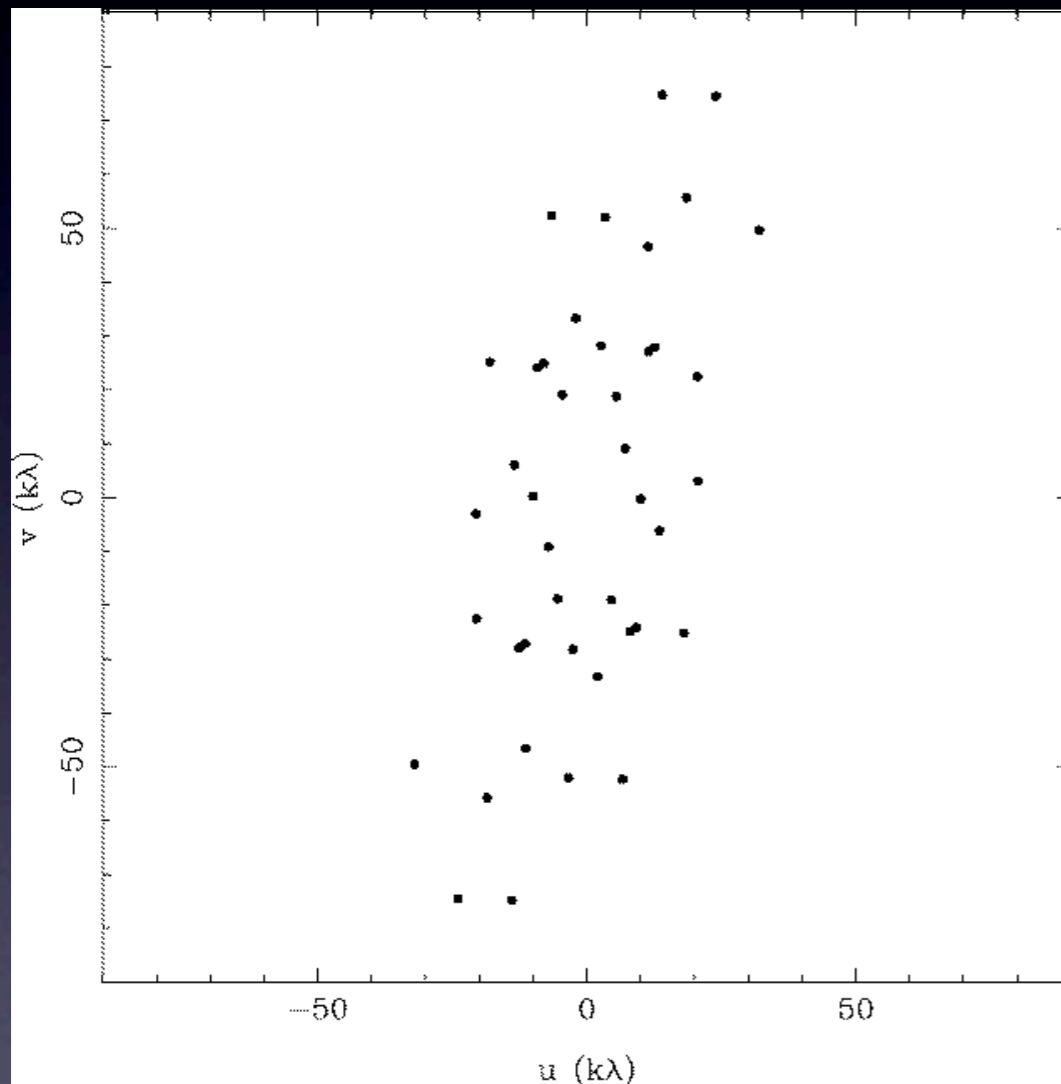

# u-v coverage: Dirty beam

8 antennas

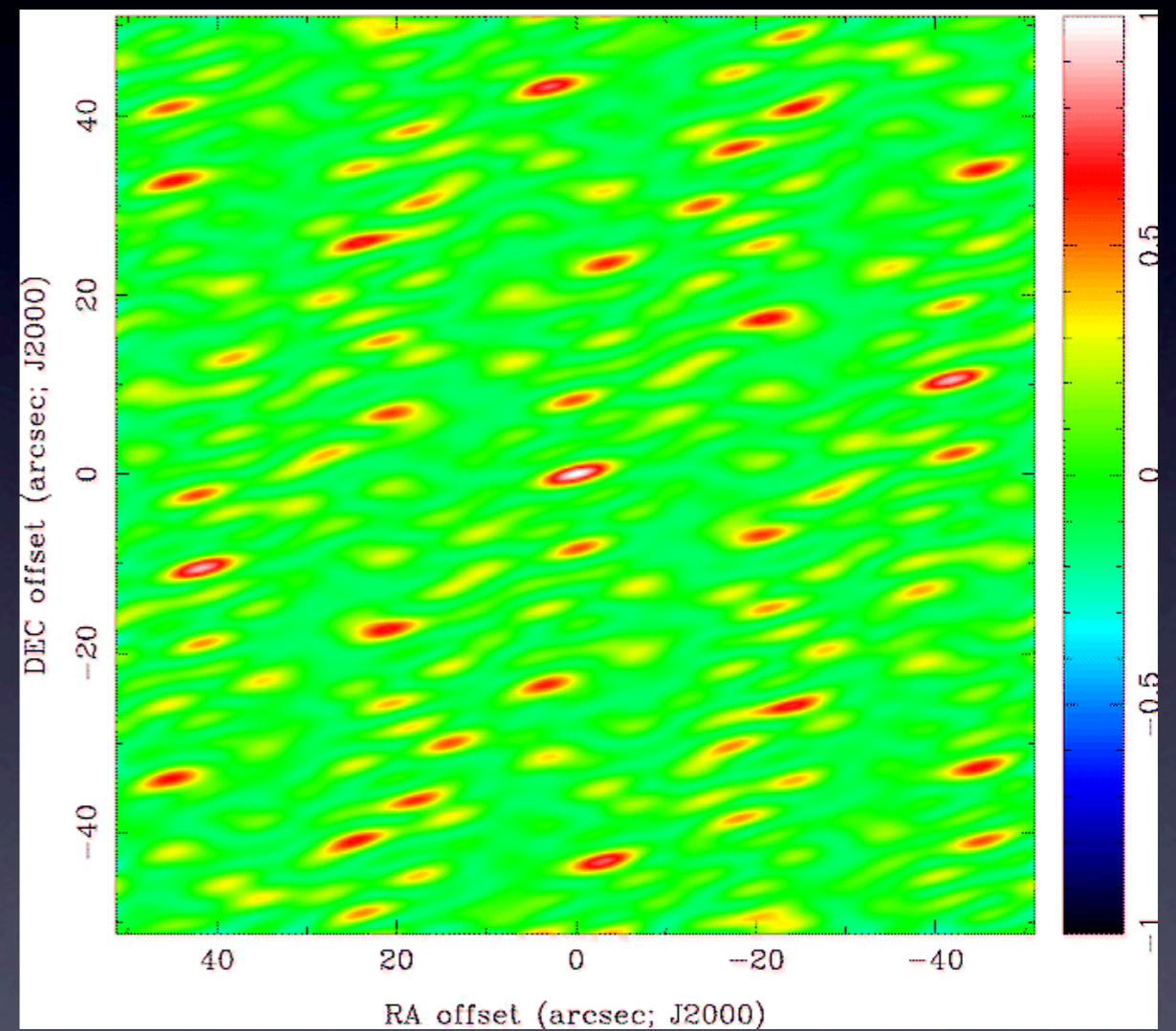
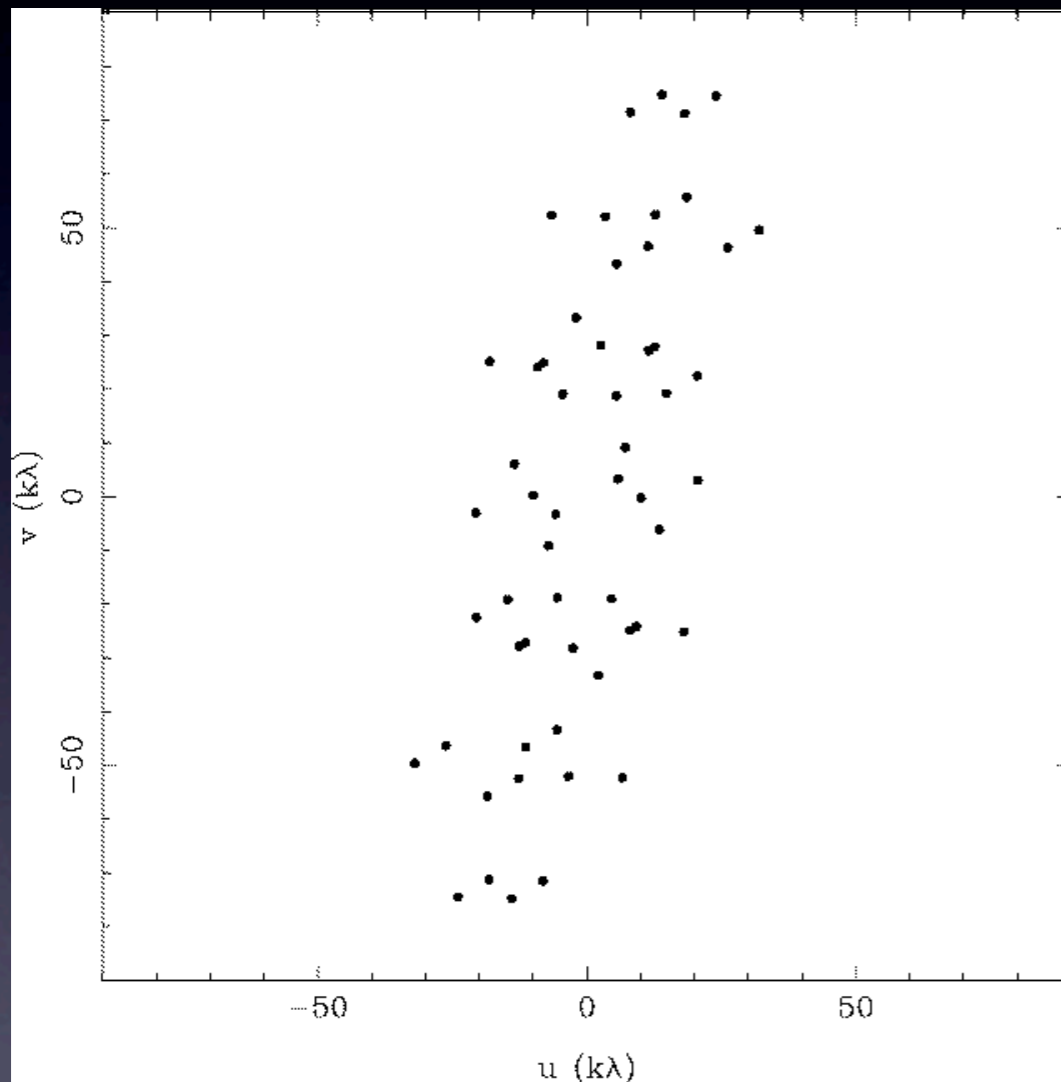

# u-v coverage: Dirty beam

8 antennas x 2 samples

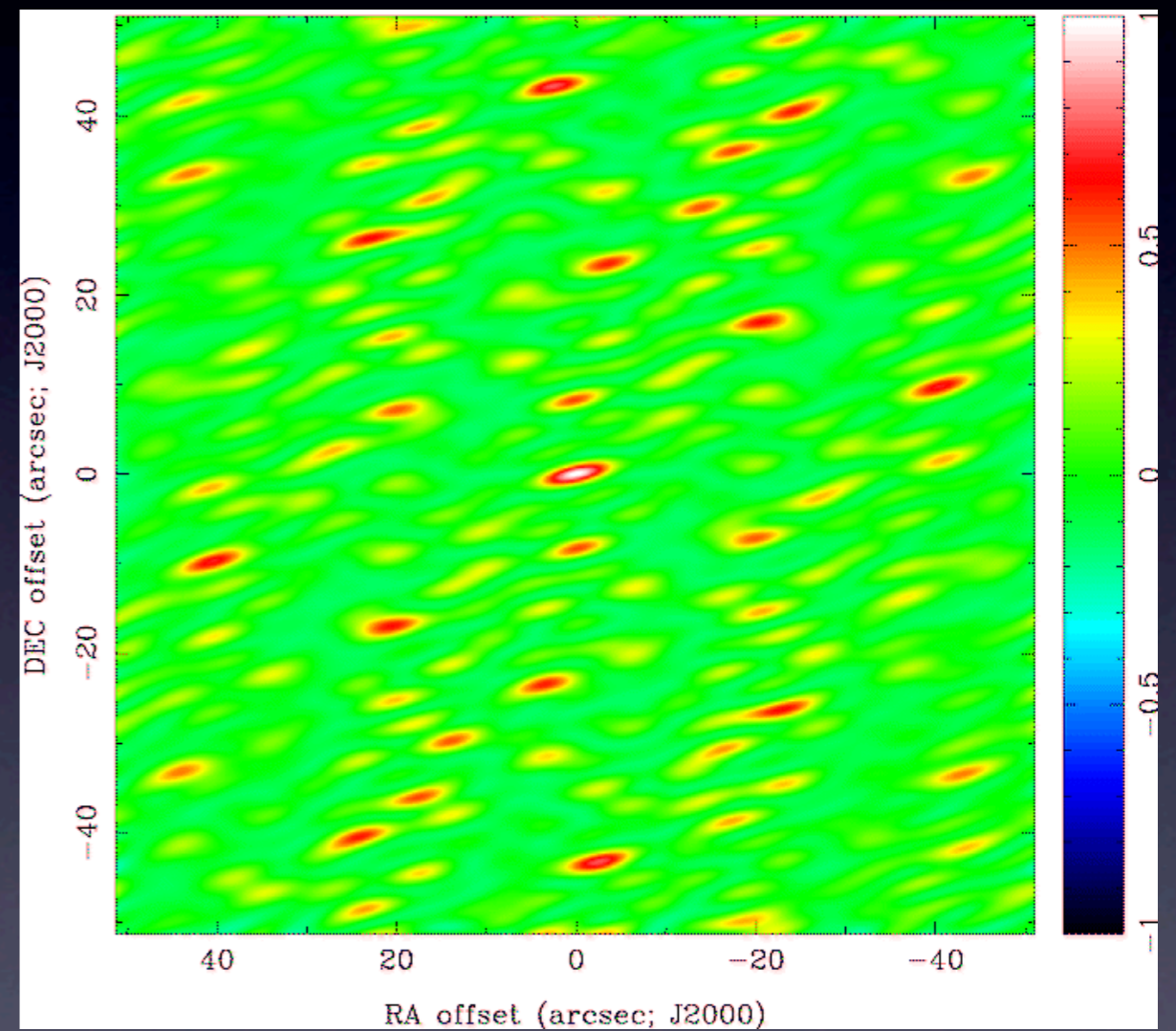
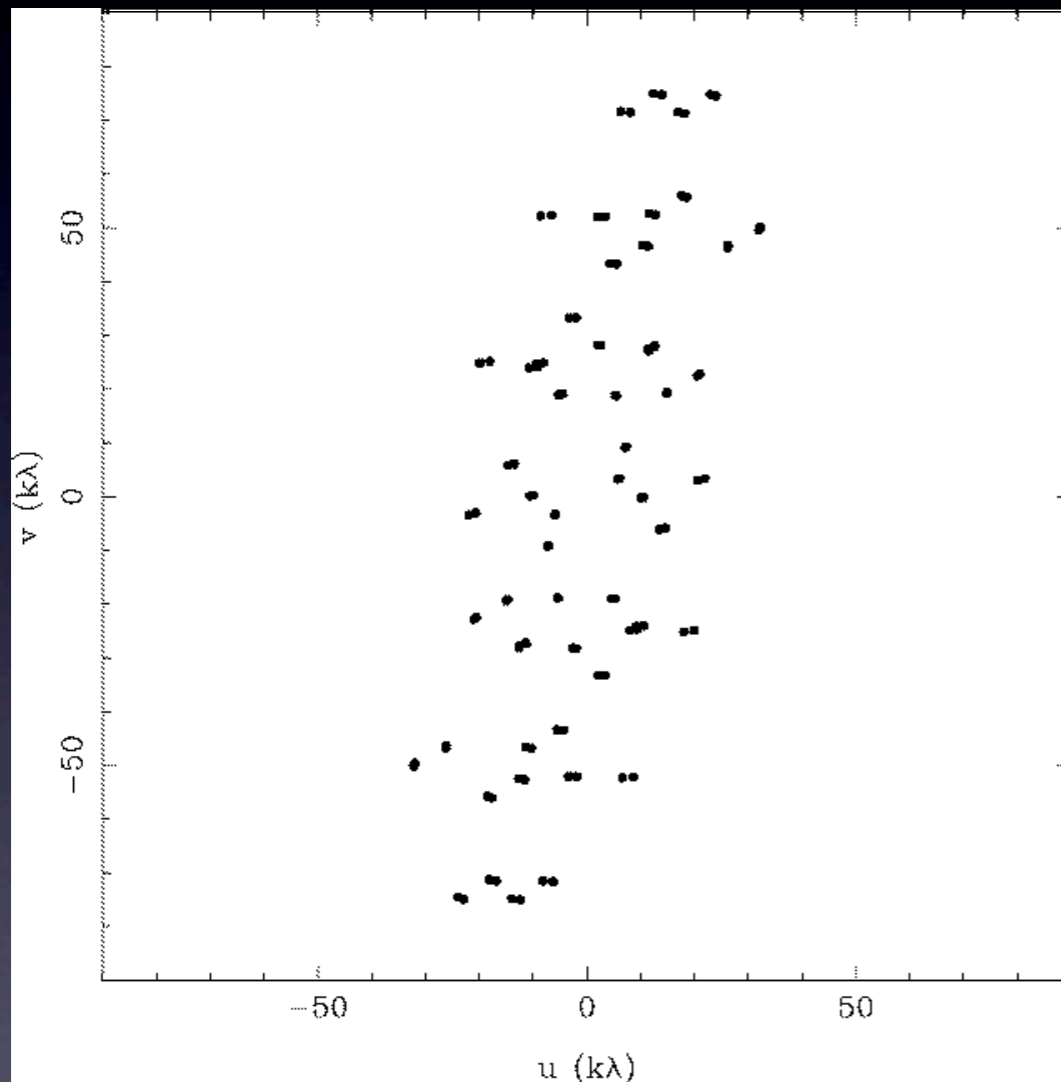

# u-v coverage: Dirty beam

8 antennas x 6 samples

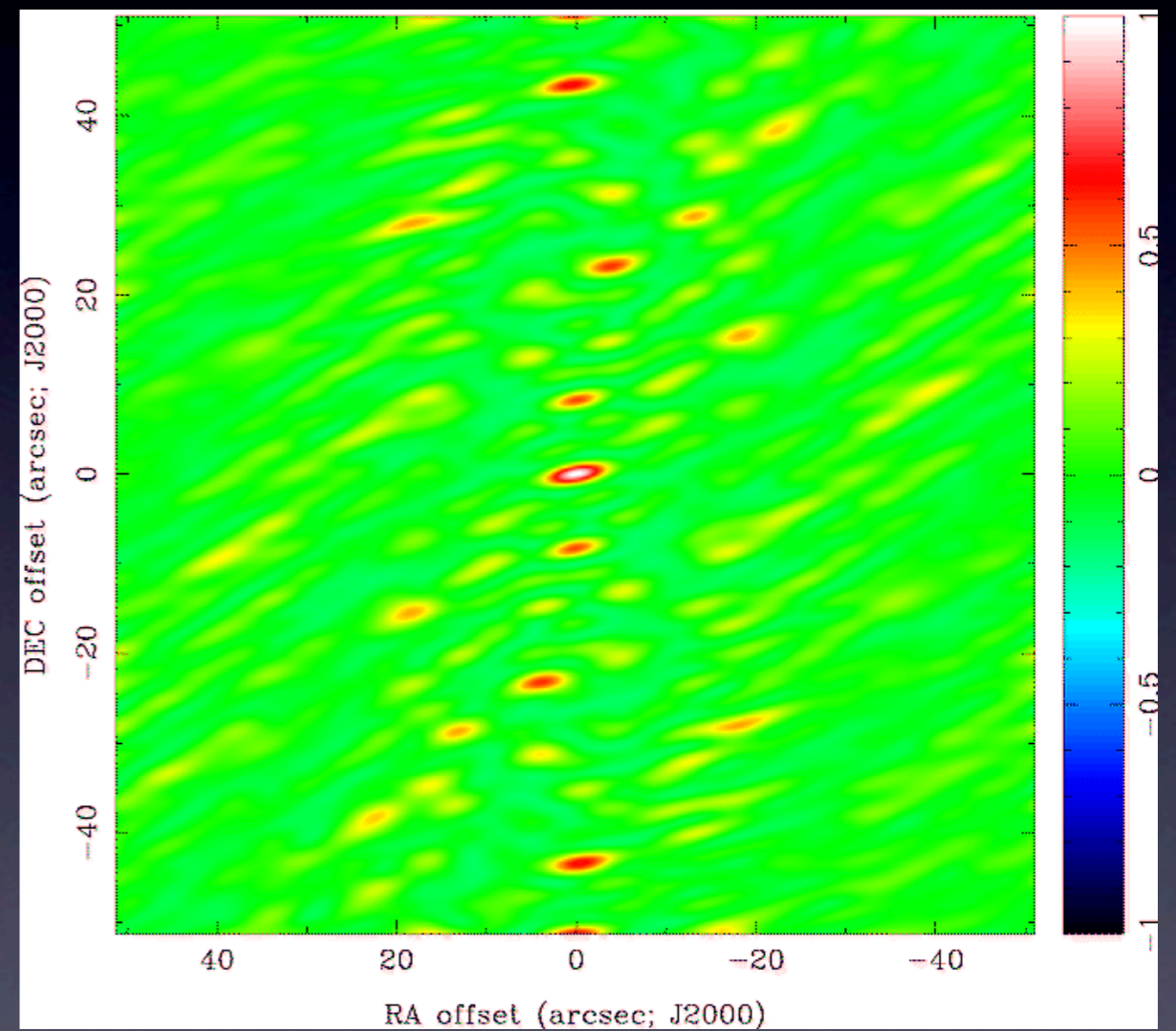
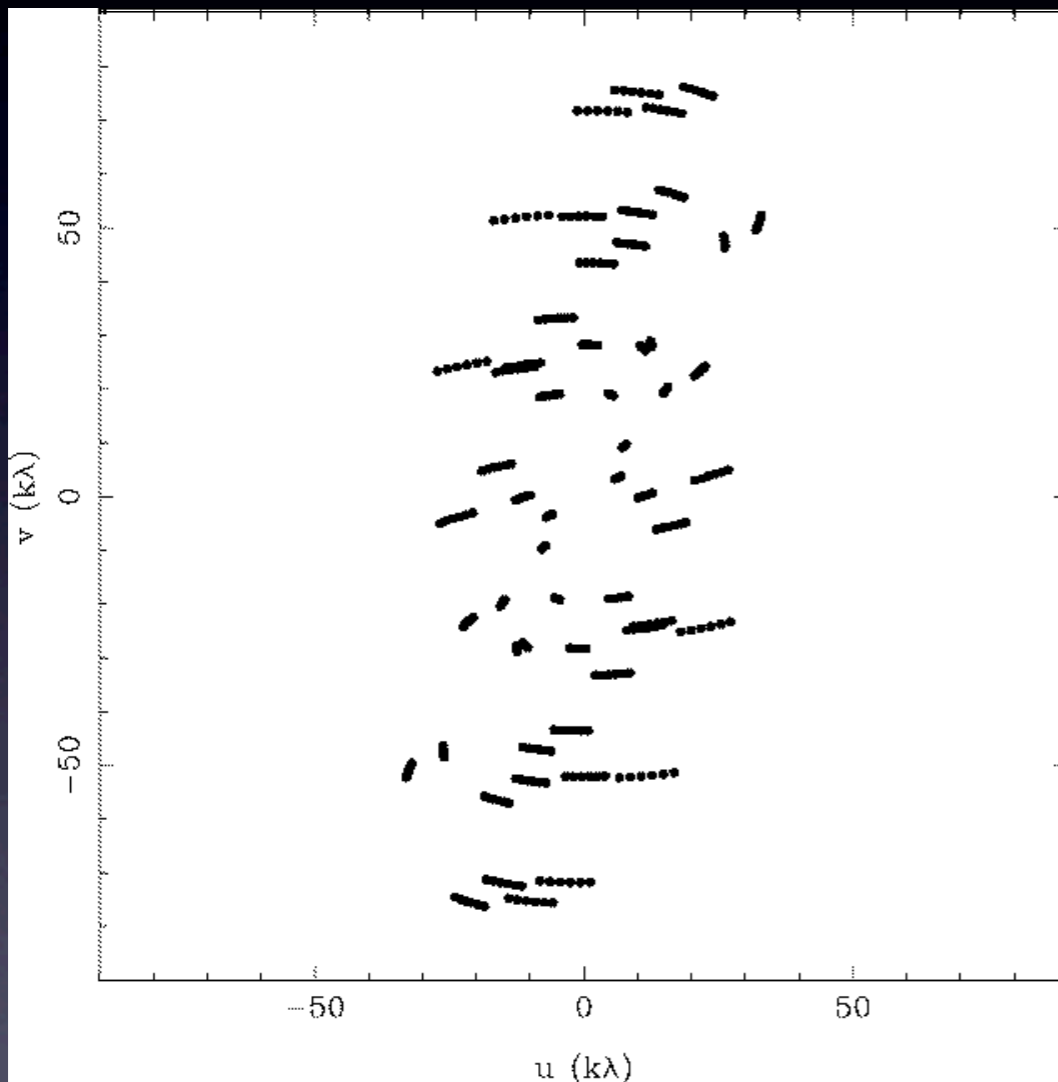

# u-v coverage: Dirty beam

8 antennas x 30 samples

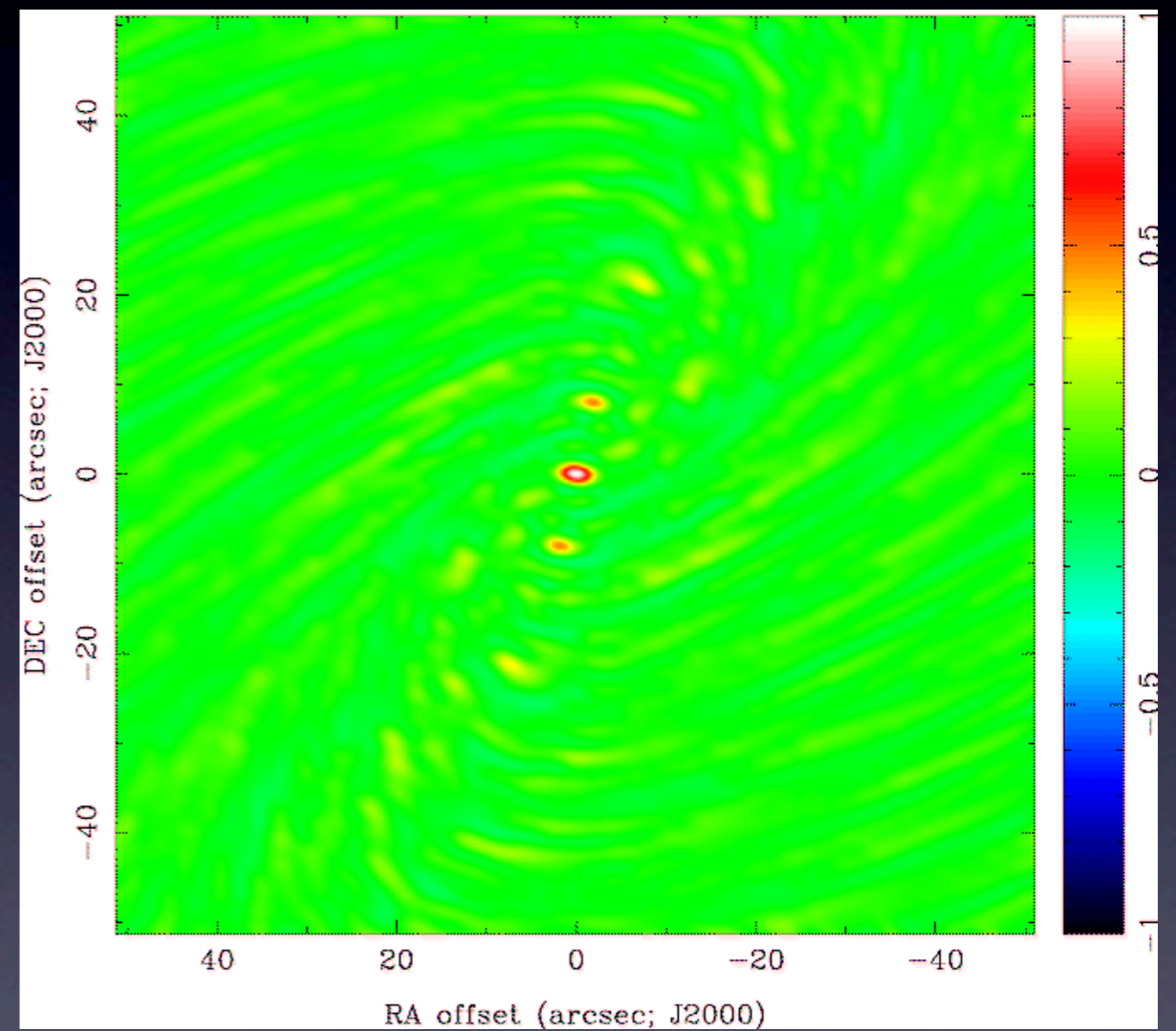
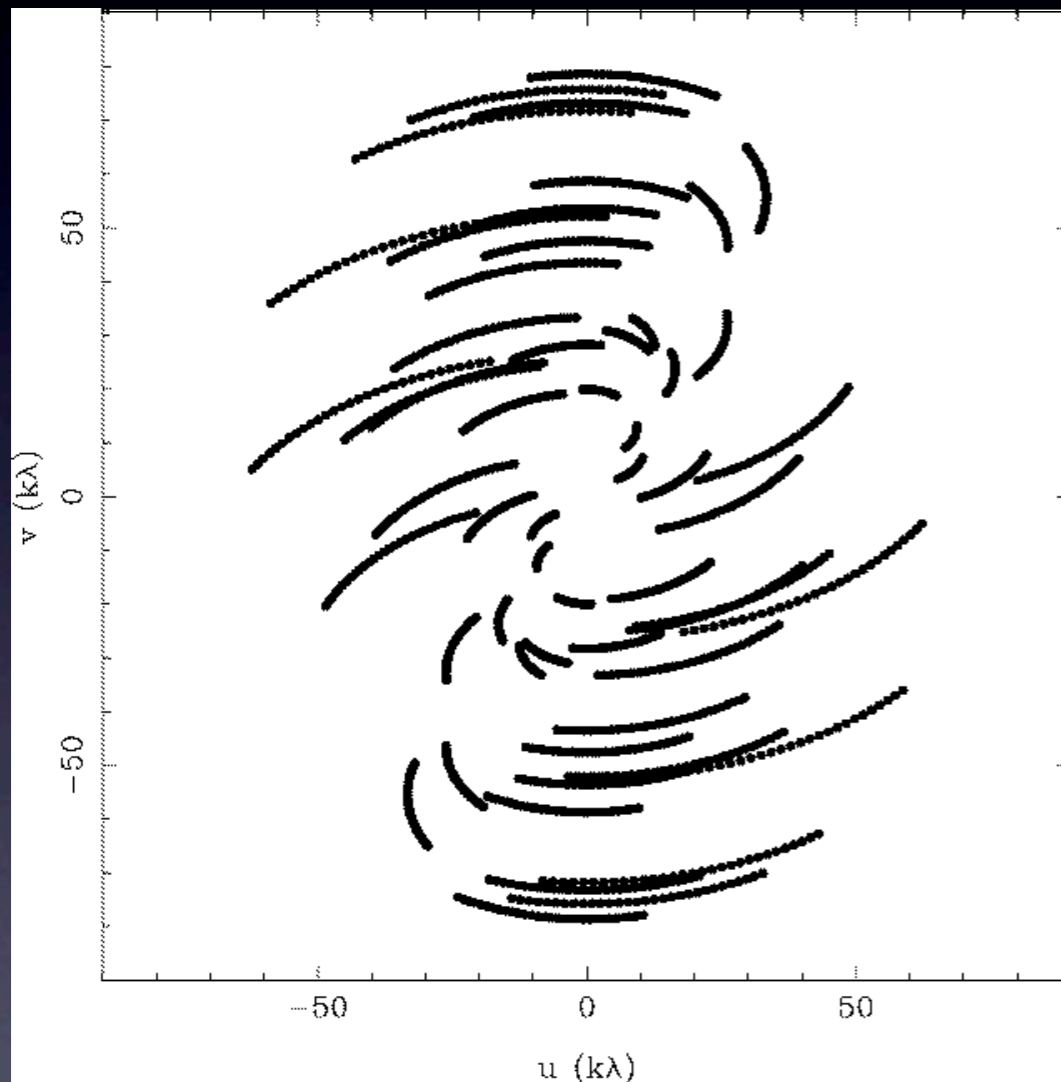

# u-v coverage: Dirty beam

8 antennas x 107 samples

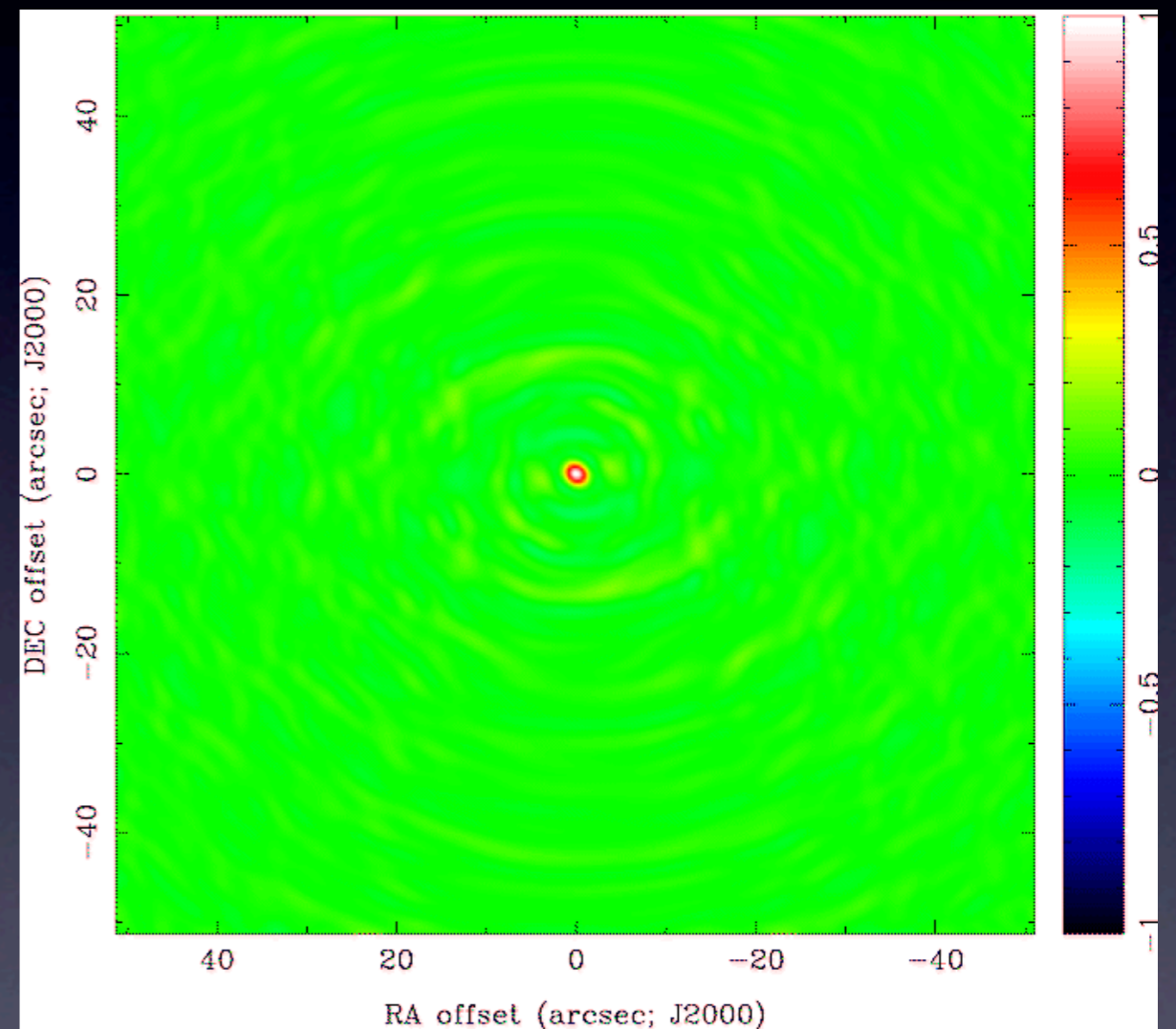
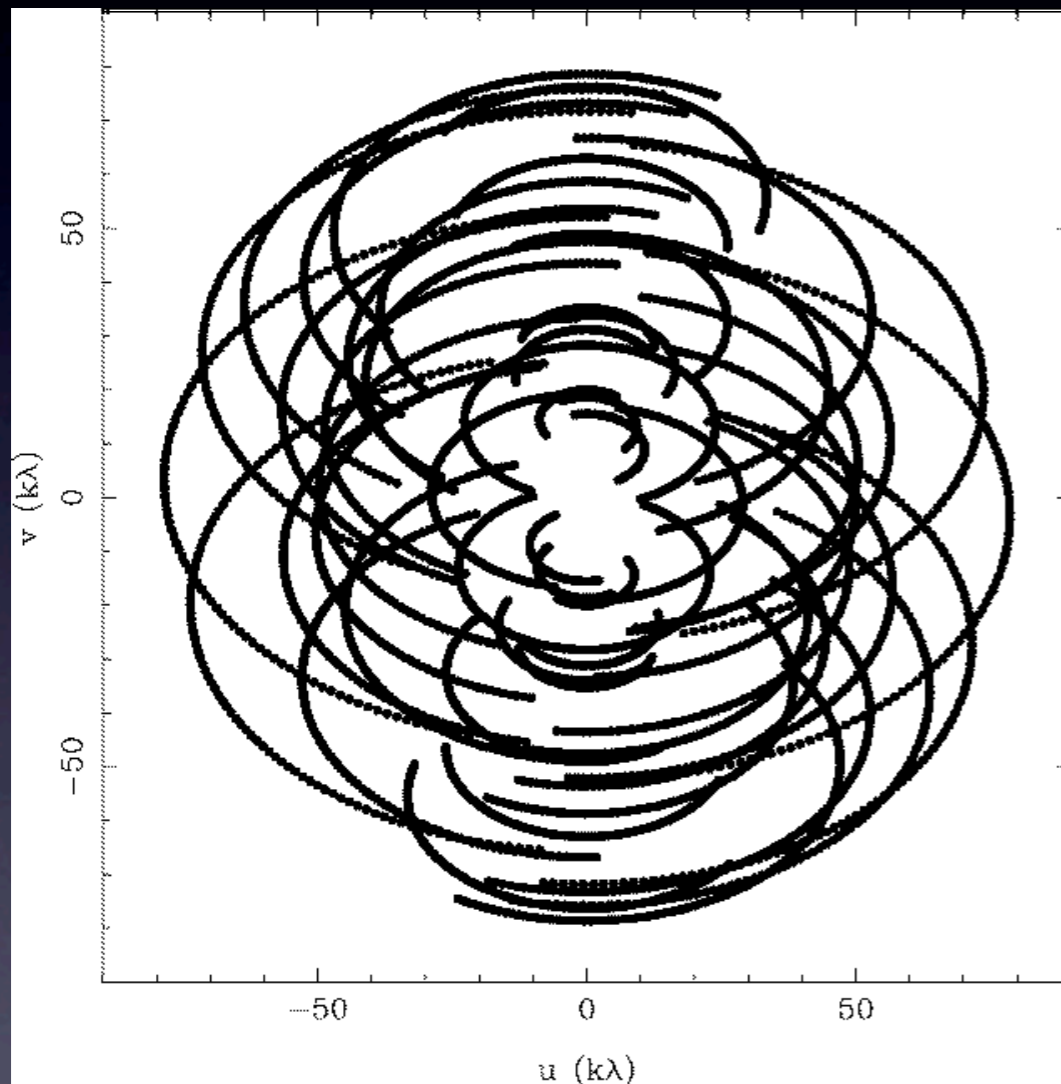



# Observations

# Main ideas

- Flux calibrator.
- Phase calibrators.
- Best u-v coverage.
- Real time VS Tapes.

# Interferometers

# Interferometers



EVLA

# Interferometers



EVLA



eMERLIN

# Interferometers



EVLA



eMERLIN



Plateau de Bure

# Interferometers



ALMA

# Interferometers



ALMA



LOFAR



# Interferometers



ALMA



SKA



LOFAR

# VLBI



# Space - VLBI



# IR and beyond...

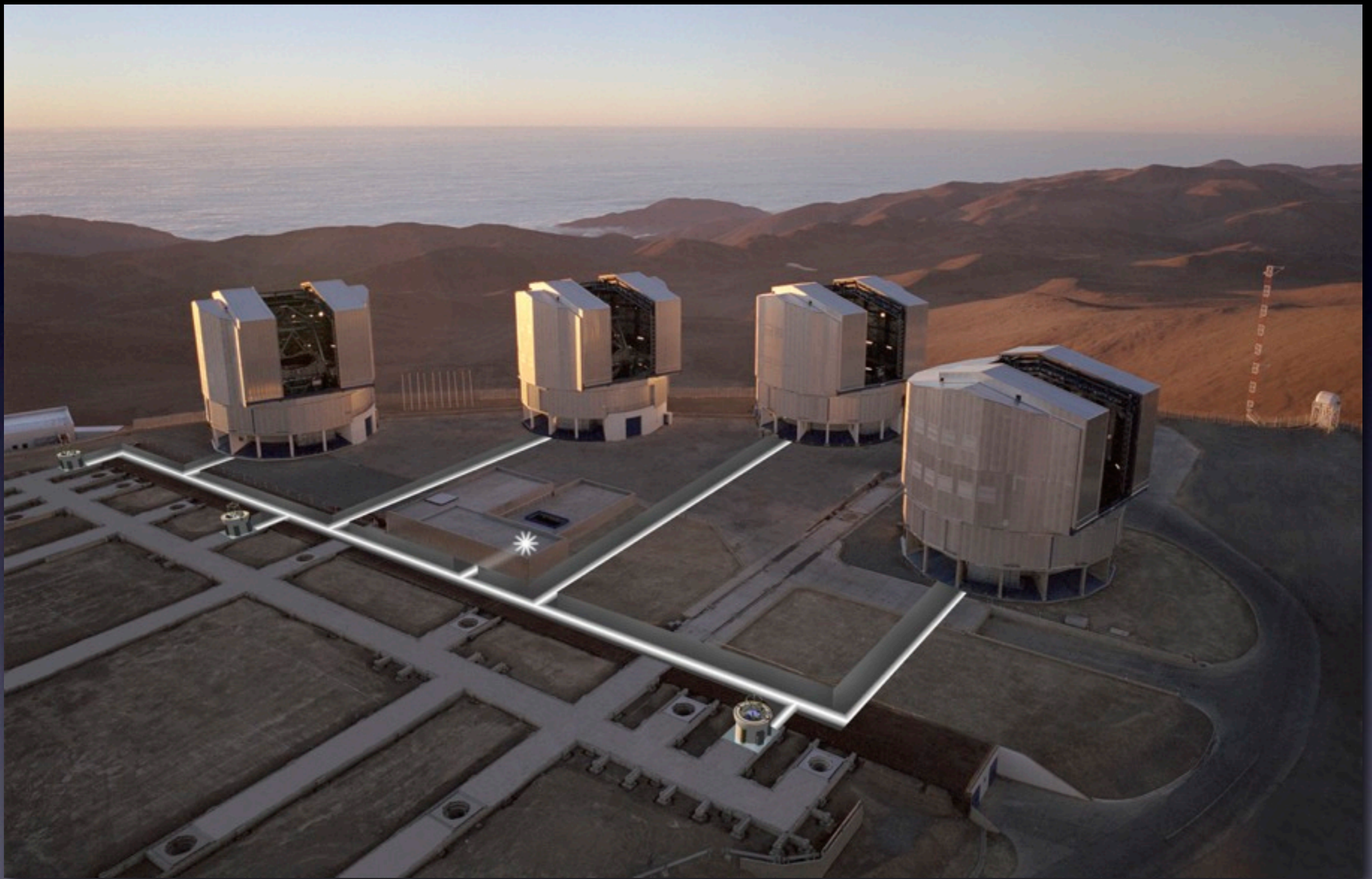

# Cygnus A

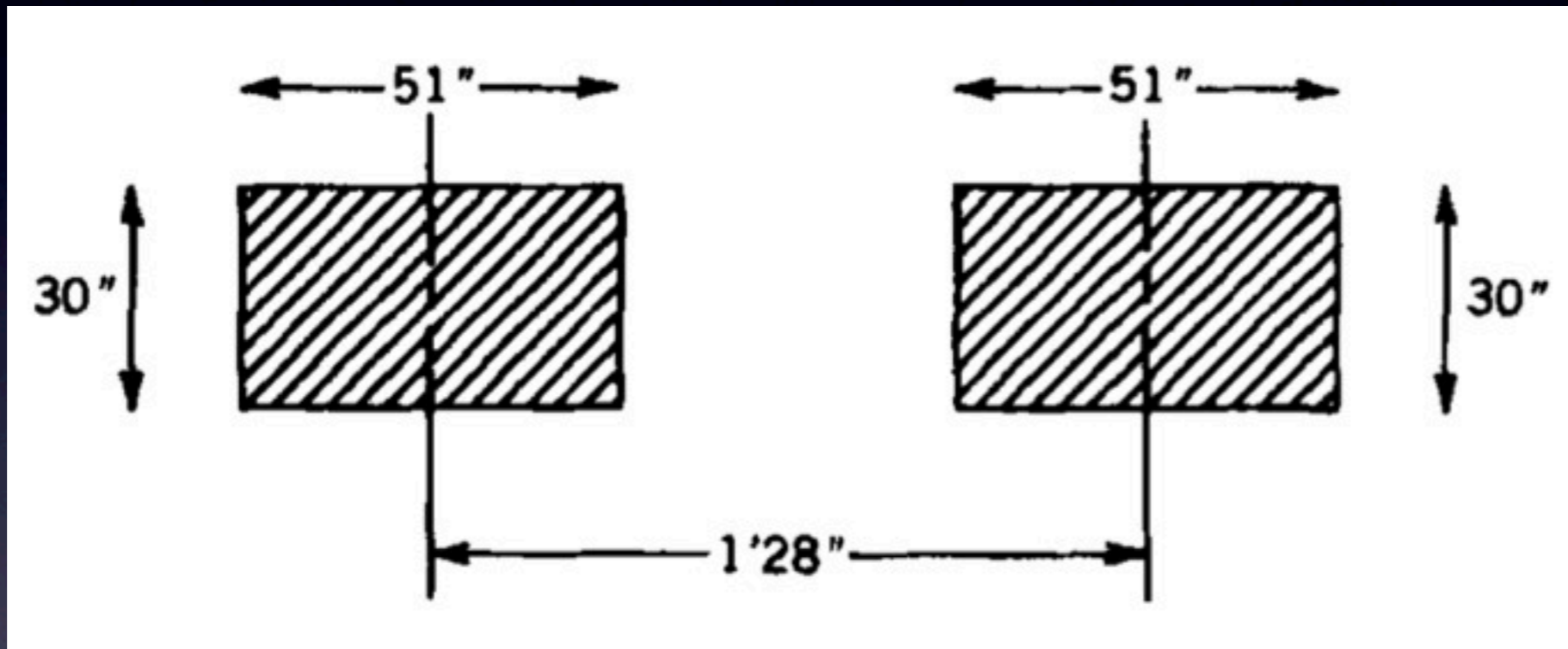

Jennison & Das Gupta (1953)

# Cygnus A

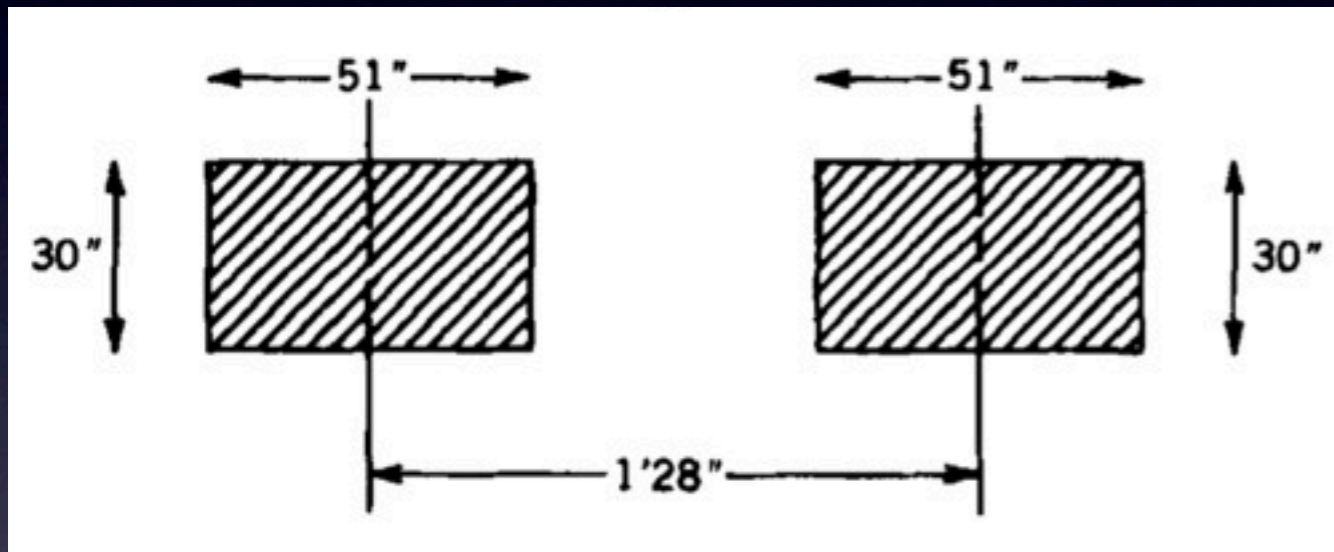

Jennison & Das Gupta (1953)

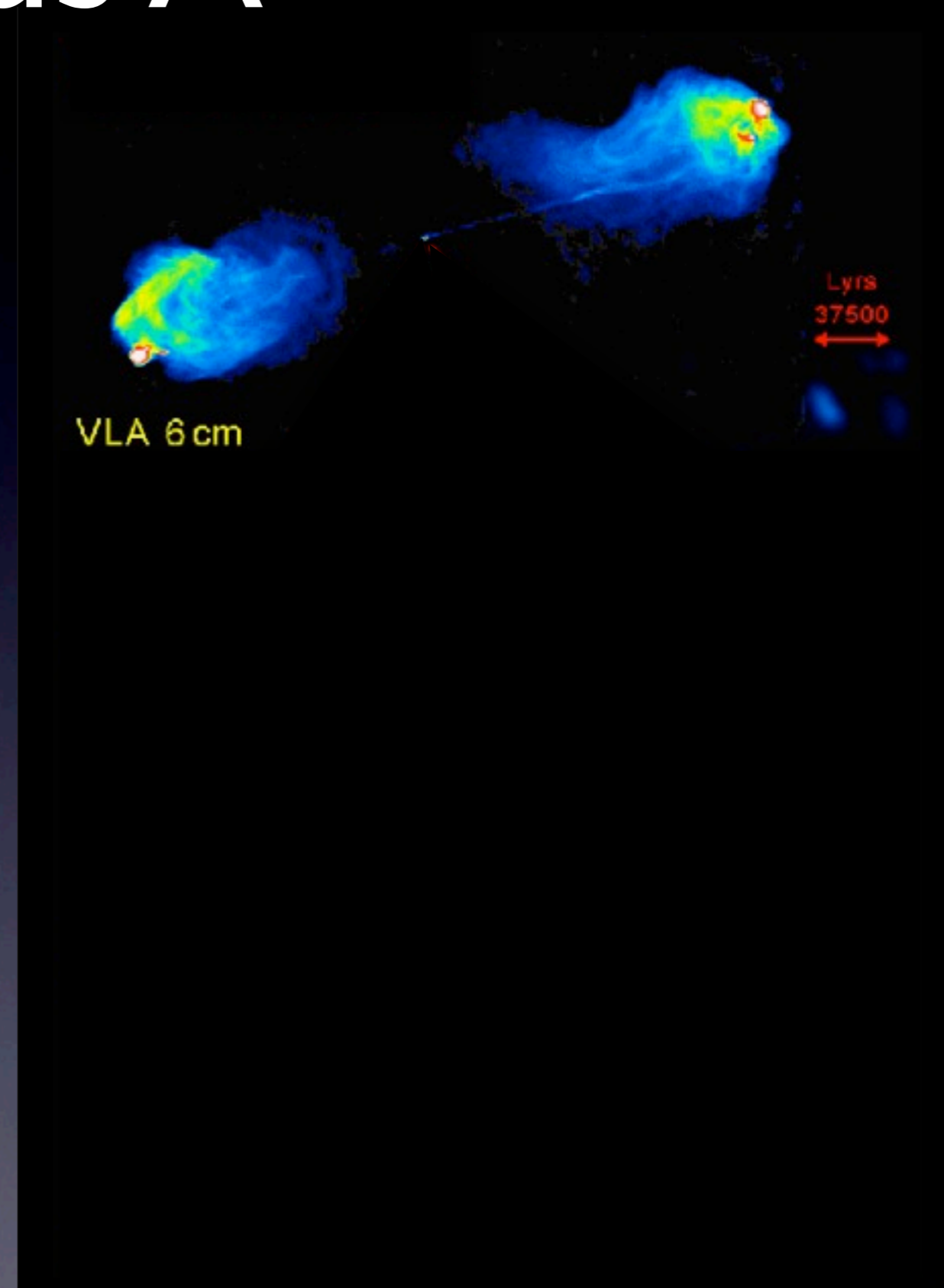

# Cygnus A

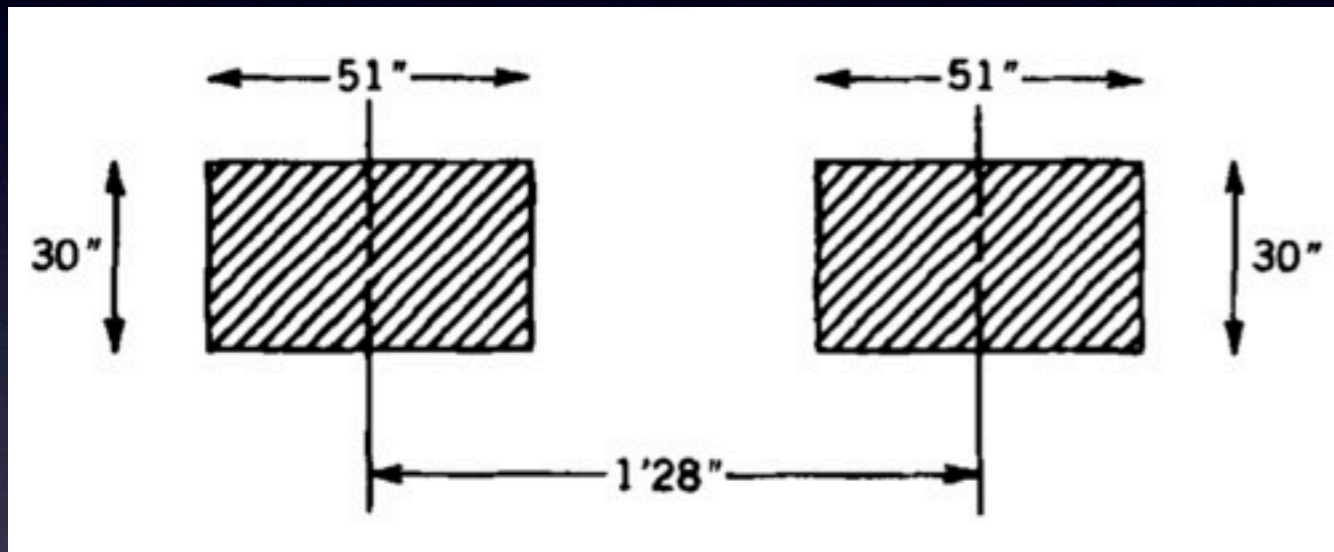

Jennison & Das Gupta (1953)

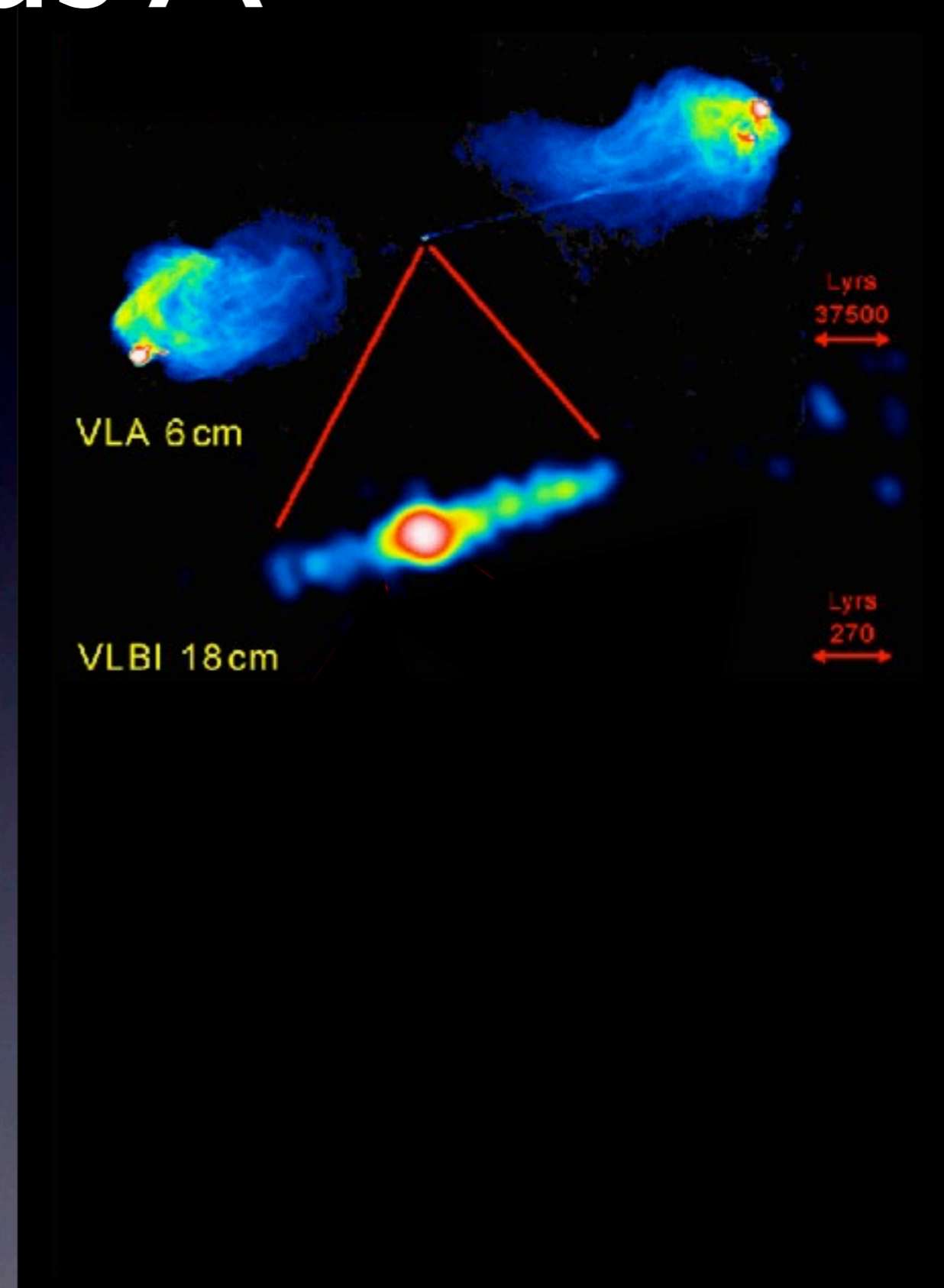

# Cygnus A

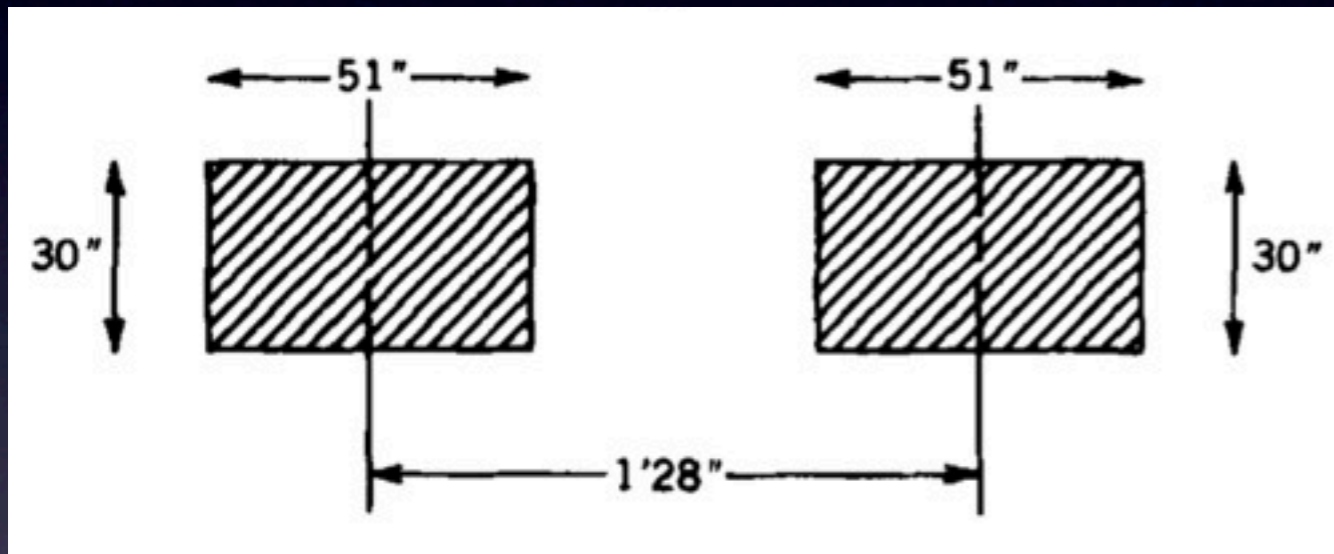

Jennison & Das Gupta (1953)

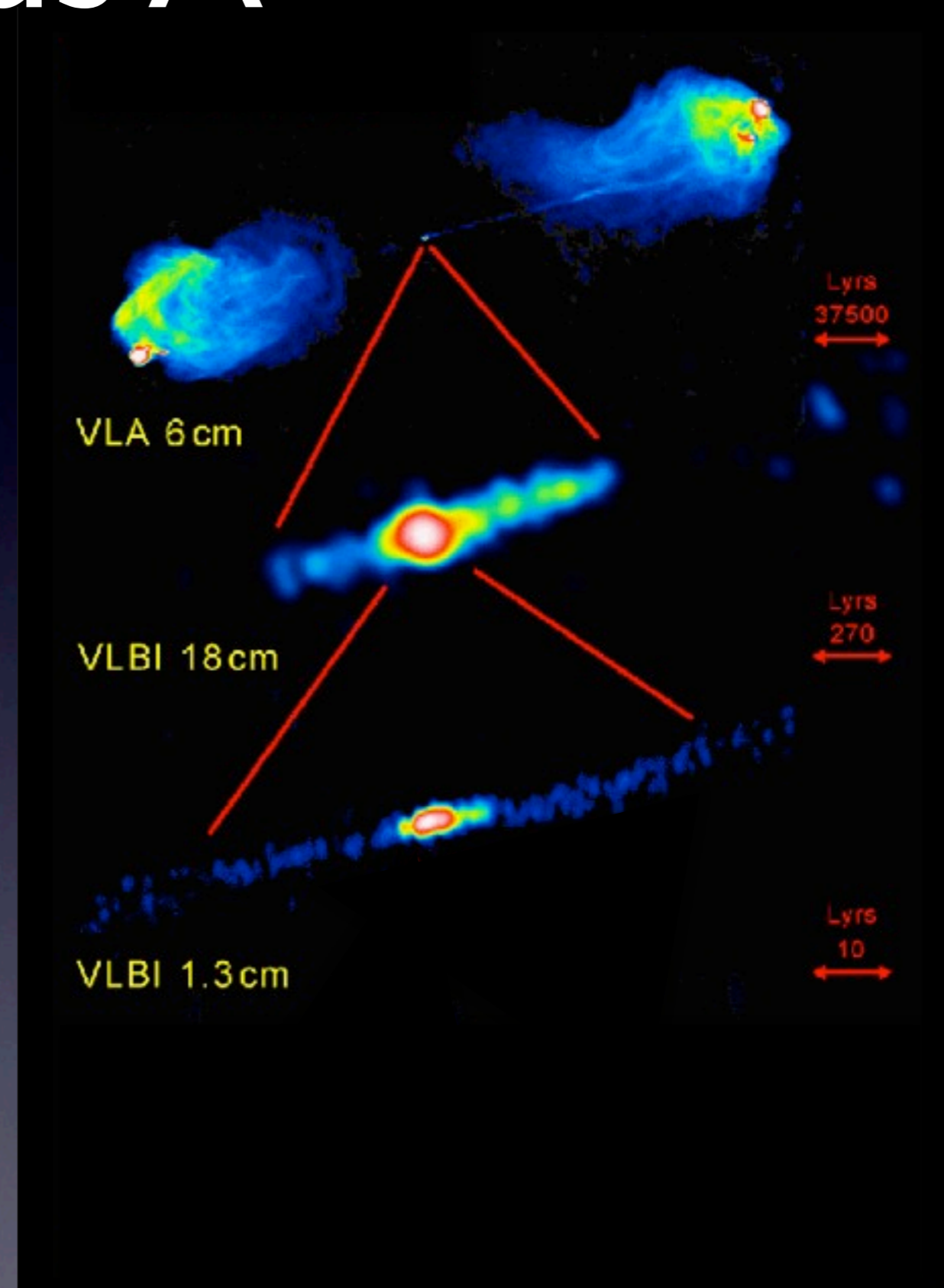



# Cygnus A

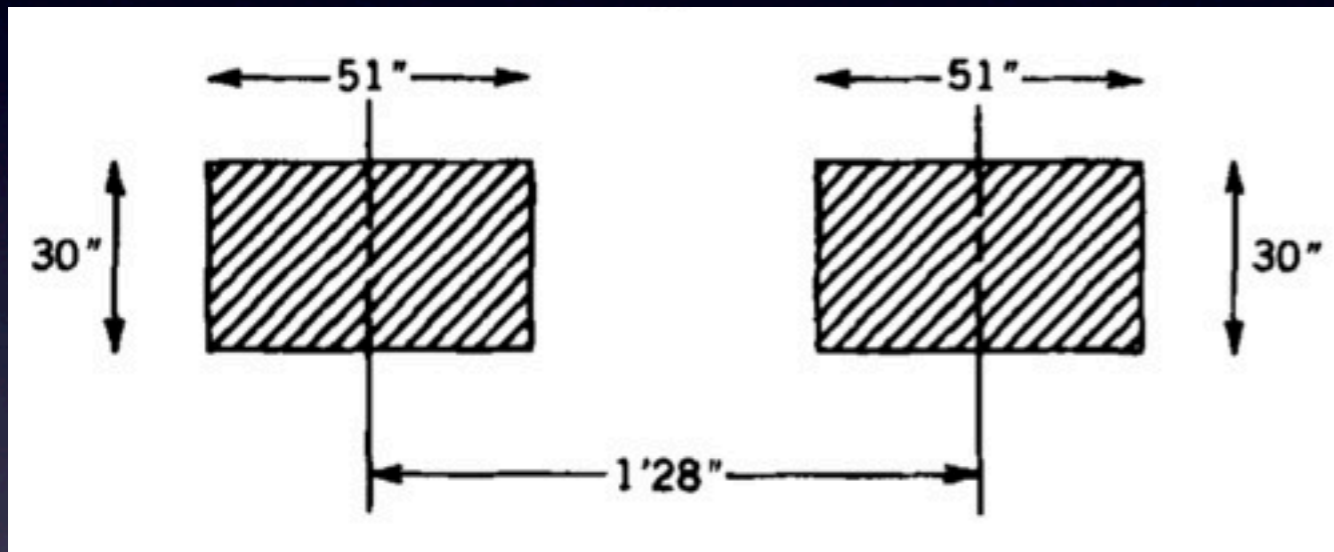

Jennison & Das Gupta (1953)

Krichbaum et al. (1998)

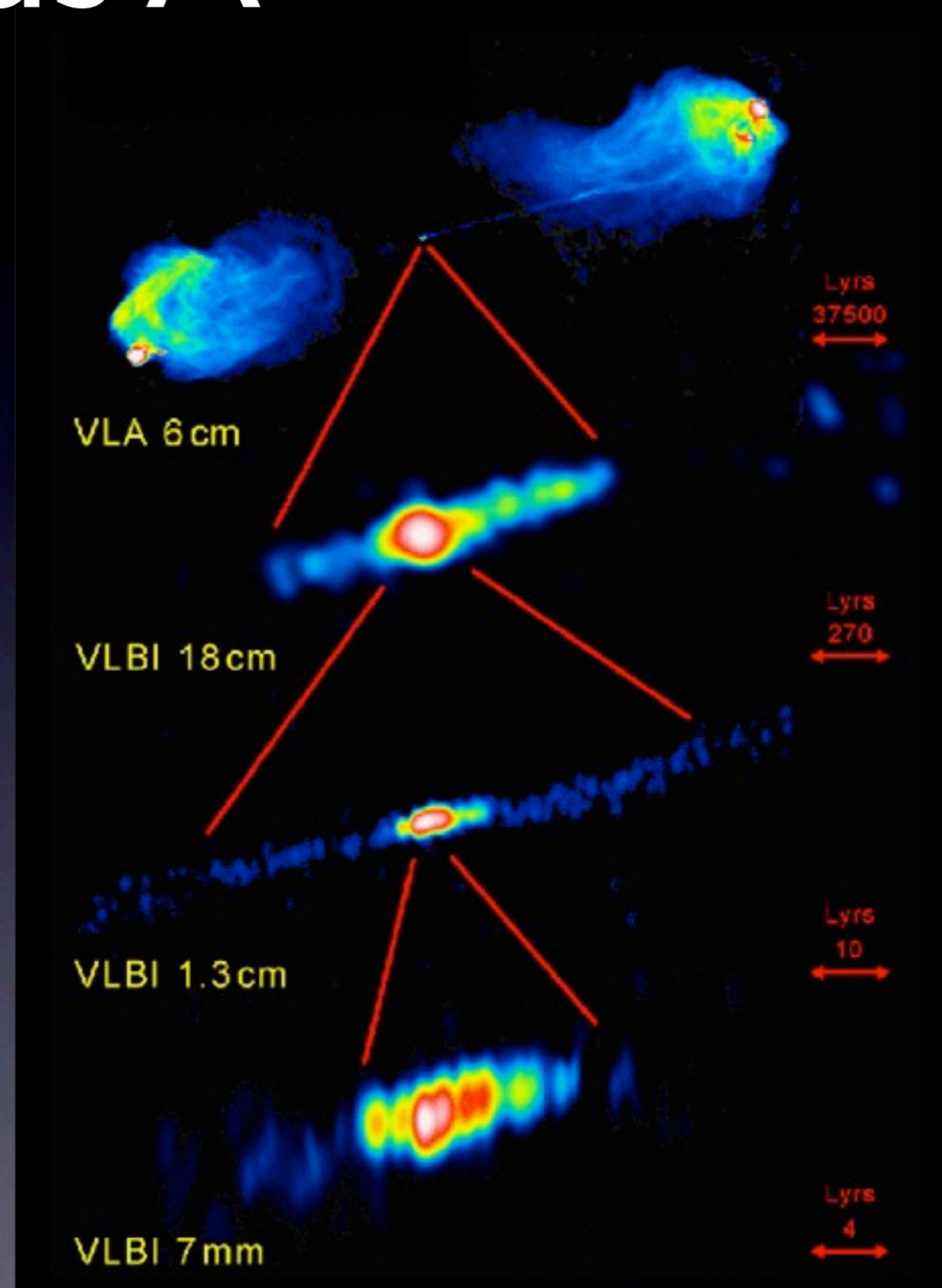

# Data reduction

# Software

## AIPS



Most powerful software.

IRAF 'like'.

Created in 1970s (ancient FORTRAN).

# Software

## AIPS



Most powerful software.

IRAF 'like'.

Created in 1970s (ancient FORTRAN).

## CASA

Developed for ALMA.

C/C++ kernel / Python interface.

Nearly completed.

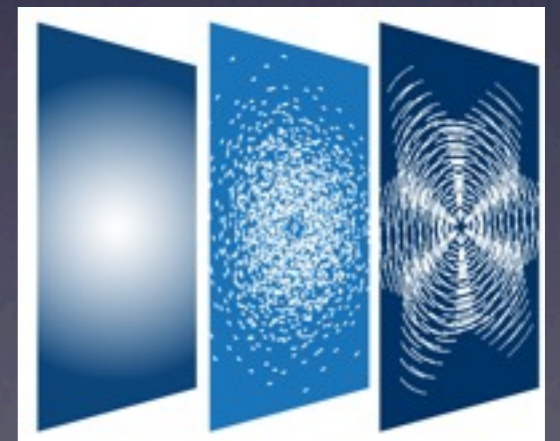

# Step by step

- Data examination.
- Amplitude calibration.
- Phase calibration.
- Imaging.

# Step by step

- Data examination.
- Amplitude calibration.
- Phase calibration.
- Imaging.

# Imaging

(J. Pety)

Source

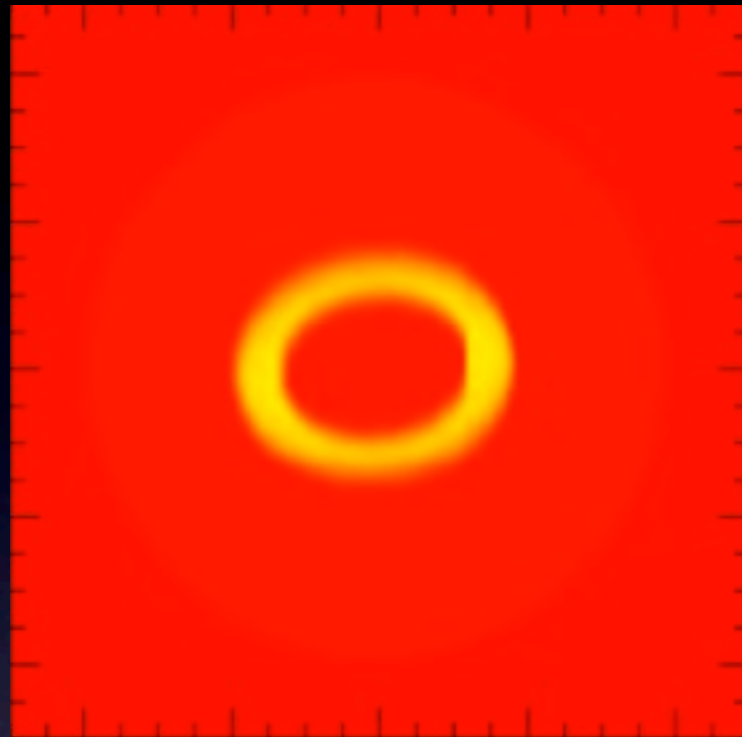

# Imaging

(J. Pety)

Source

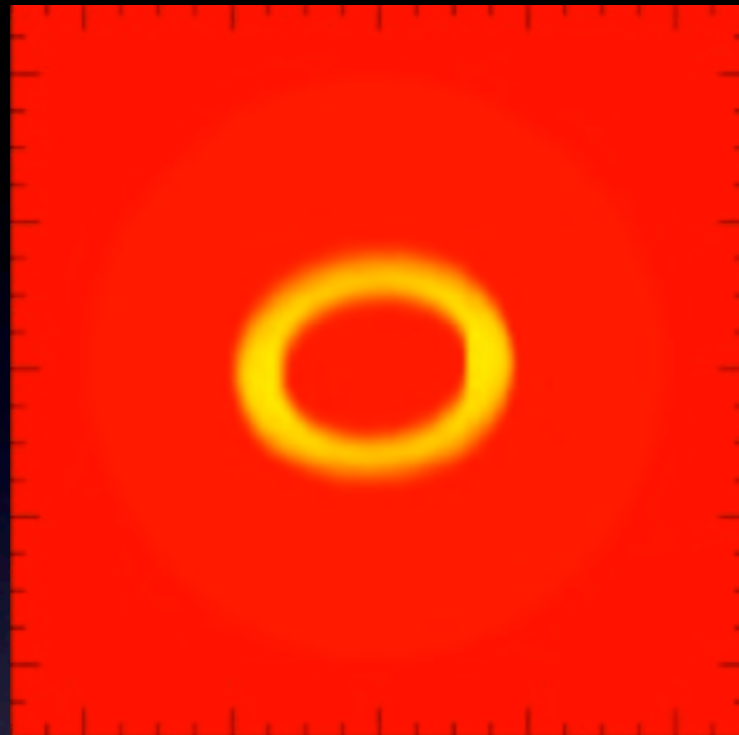

Dirty beam  
(PSF)

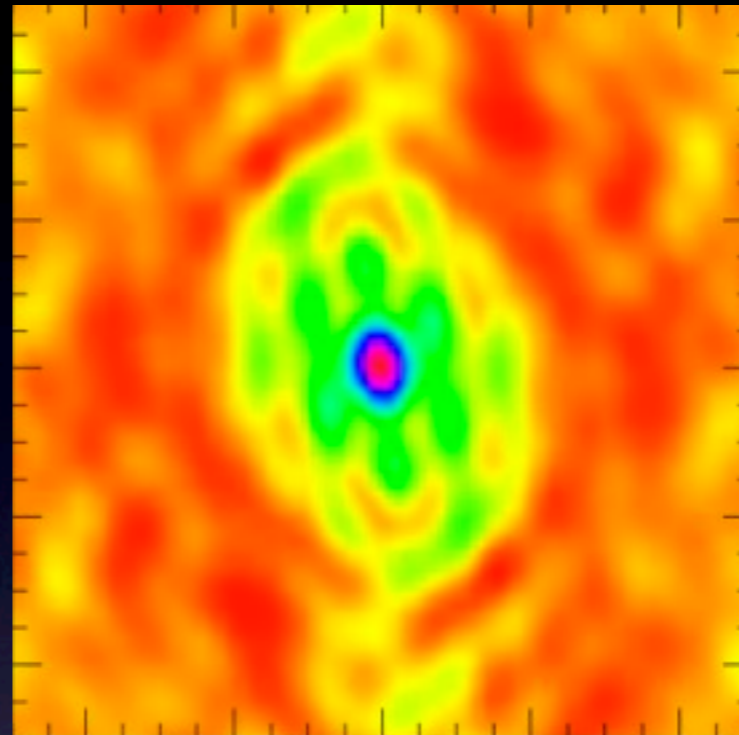



# Imaging

(J. Pety)

Source

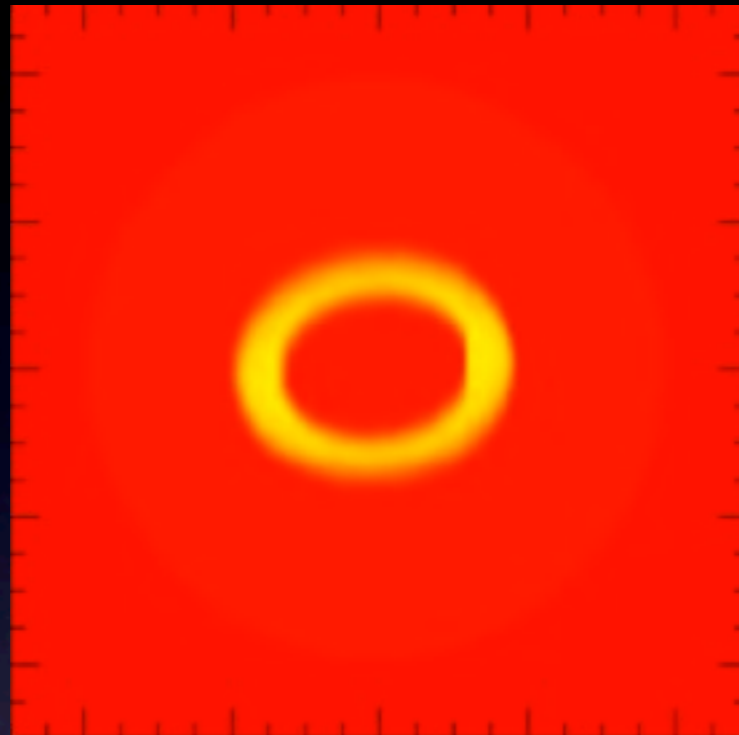

Dirty beam  
(PSF)

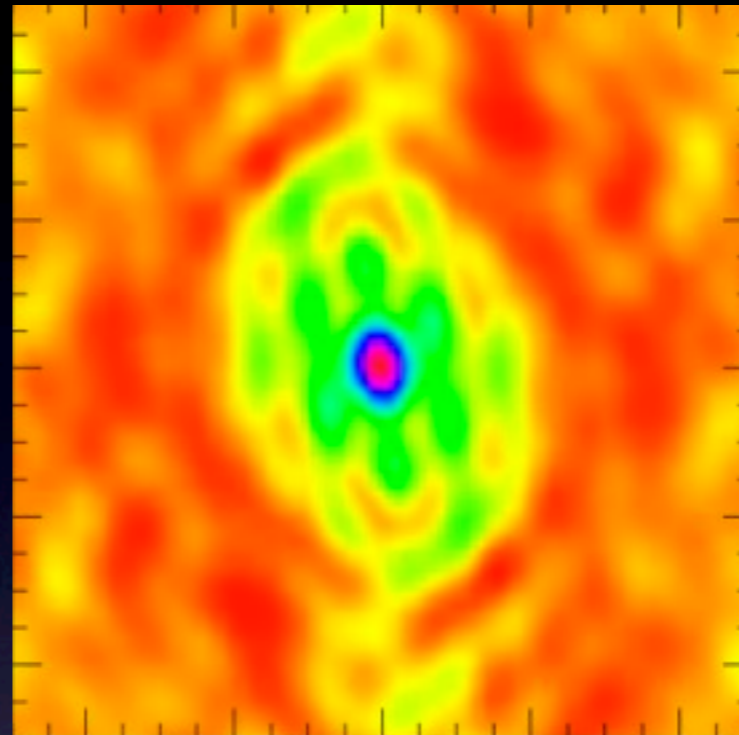

Dirty  
image

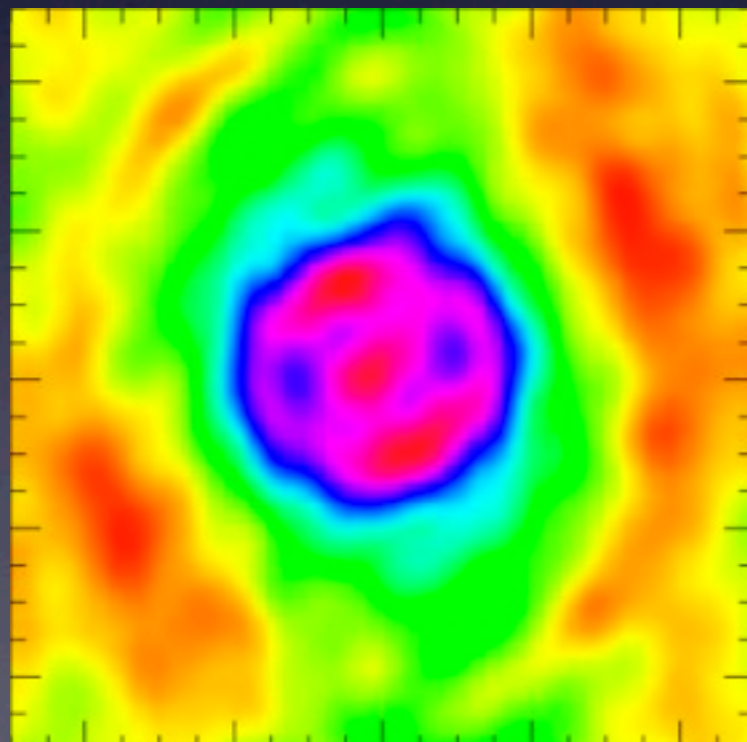

# Imaging

(J. Pety)

Source

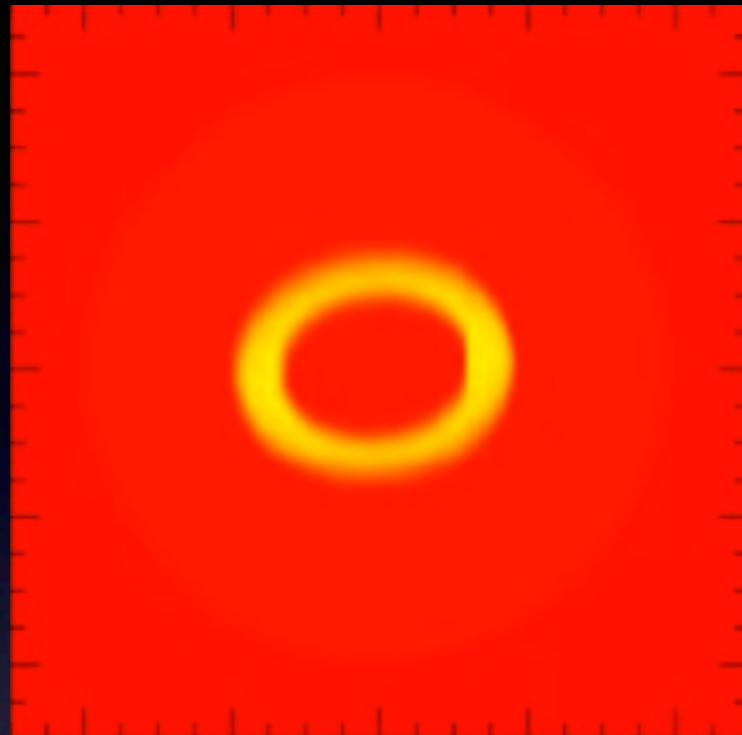

Dirty beam  
(PSF)

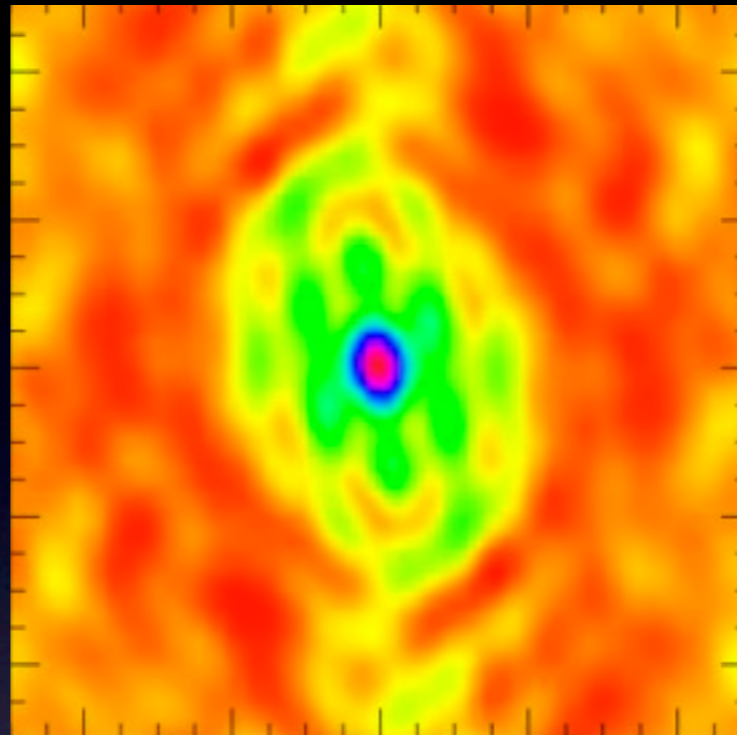

Dirty  
image

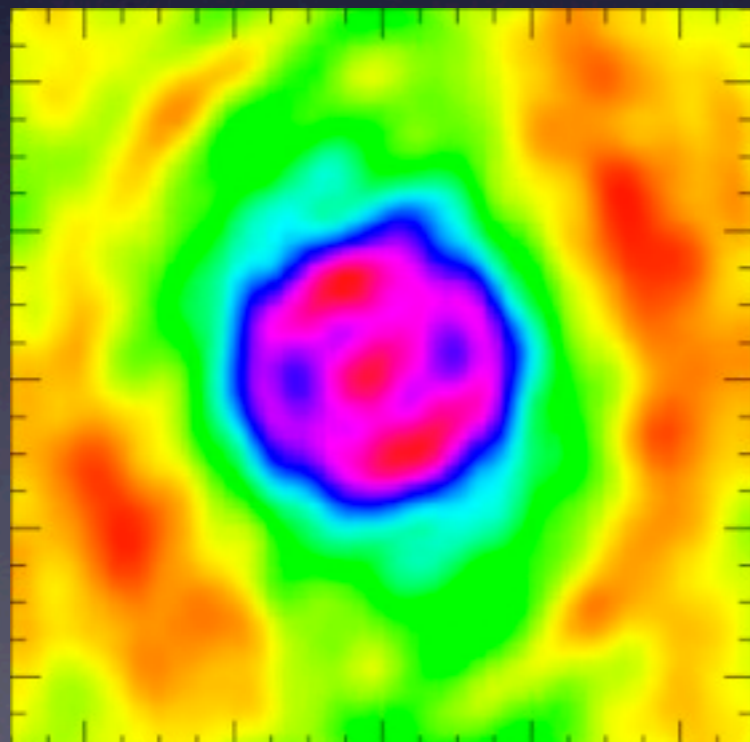

Clean  
image

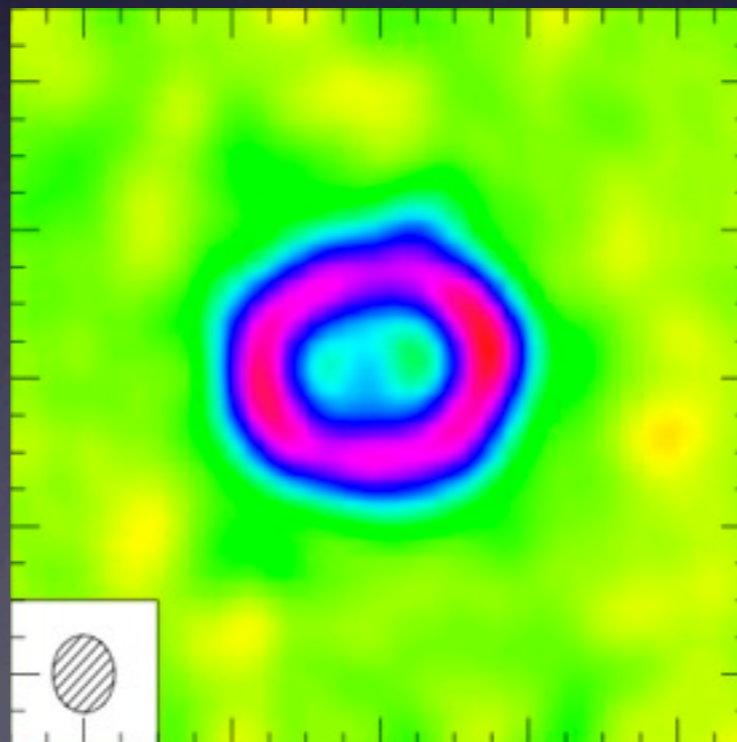

# Some examples (LIRG biased!)

# Arp 299: Hunting SNe & AGN

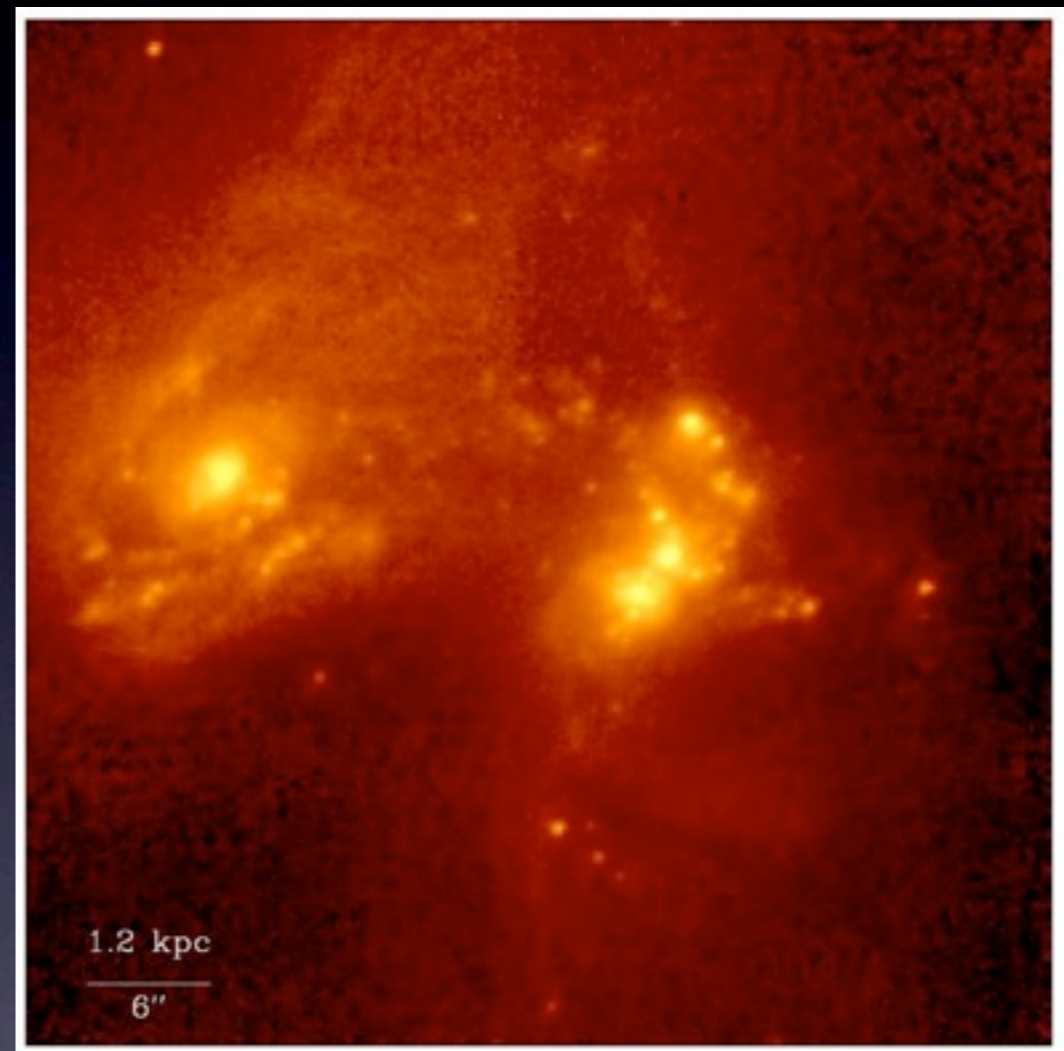
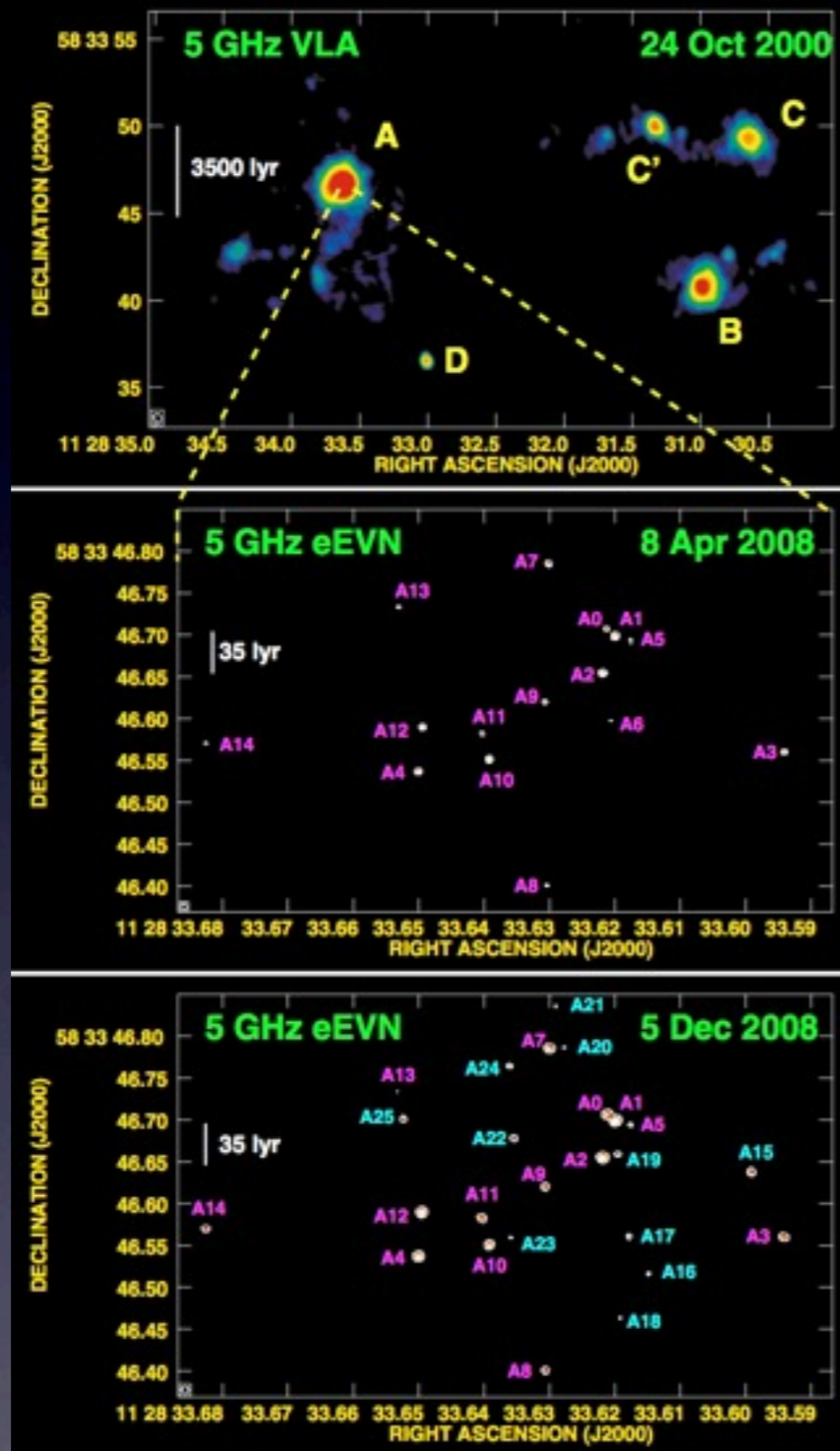

Pérez-Torres et al. 2009

# Arp 299: Hunting SNe & AGN

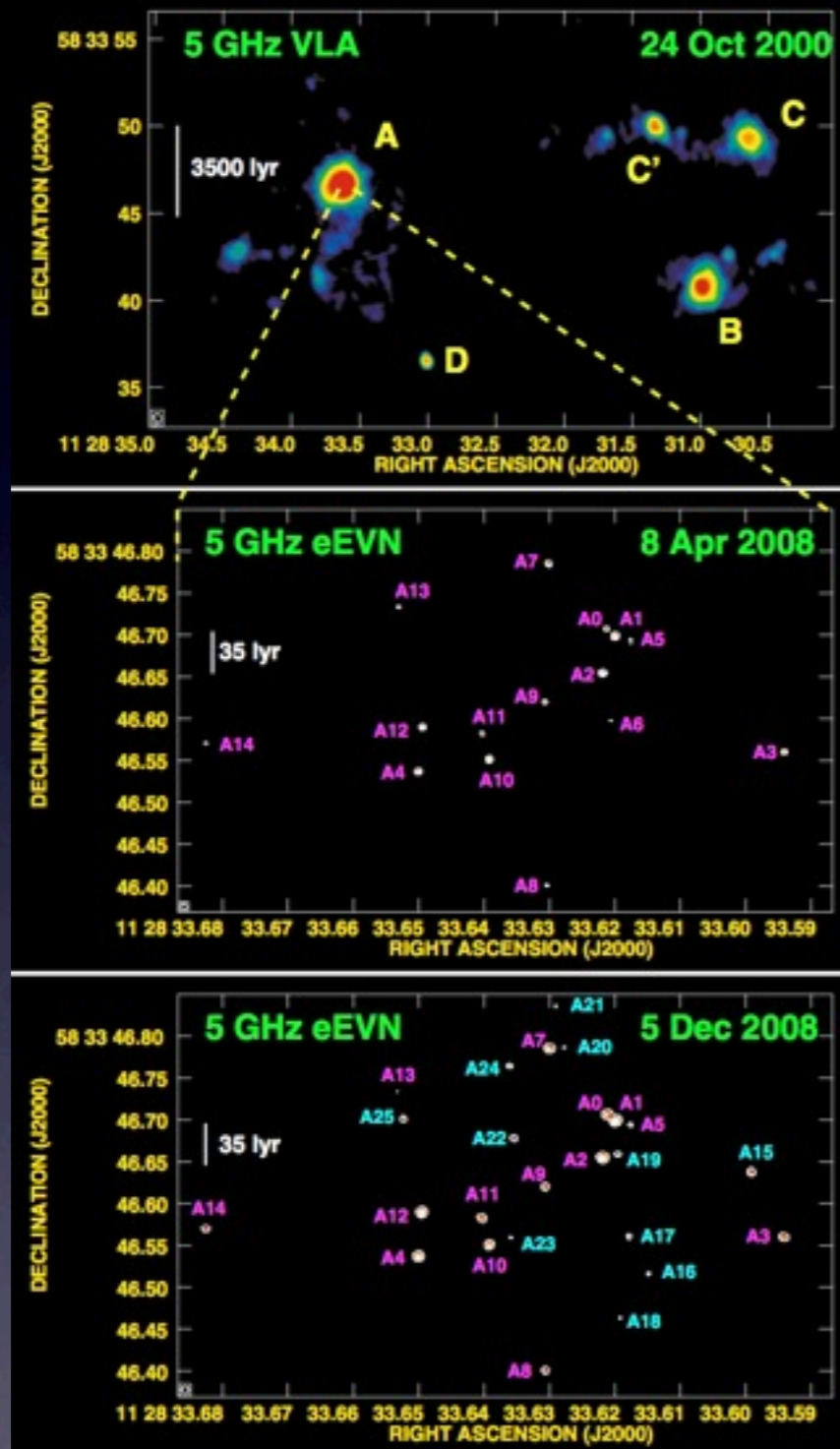

Pérez-Torres et al. 2009

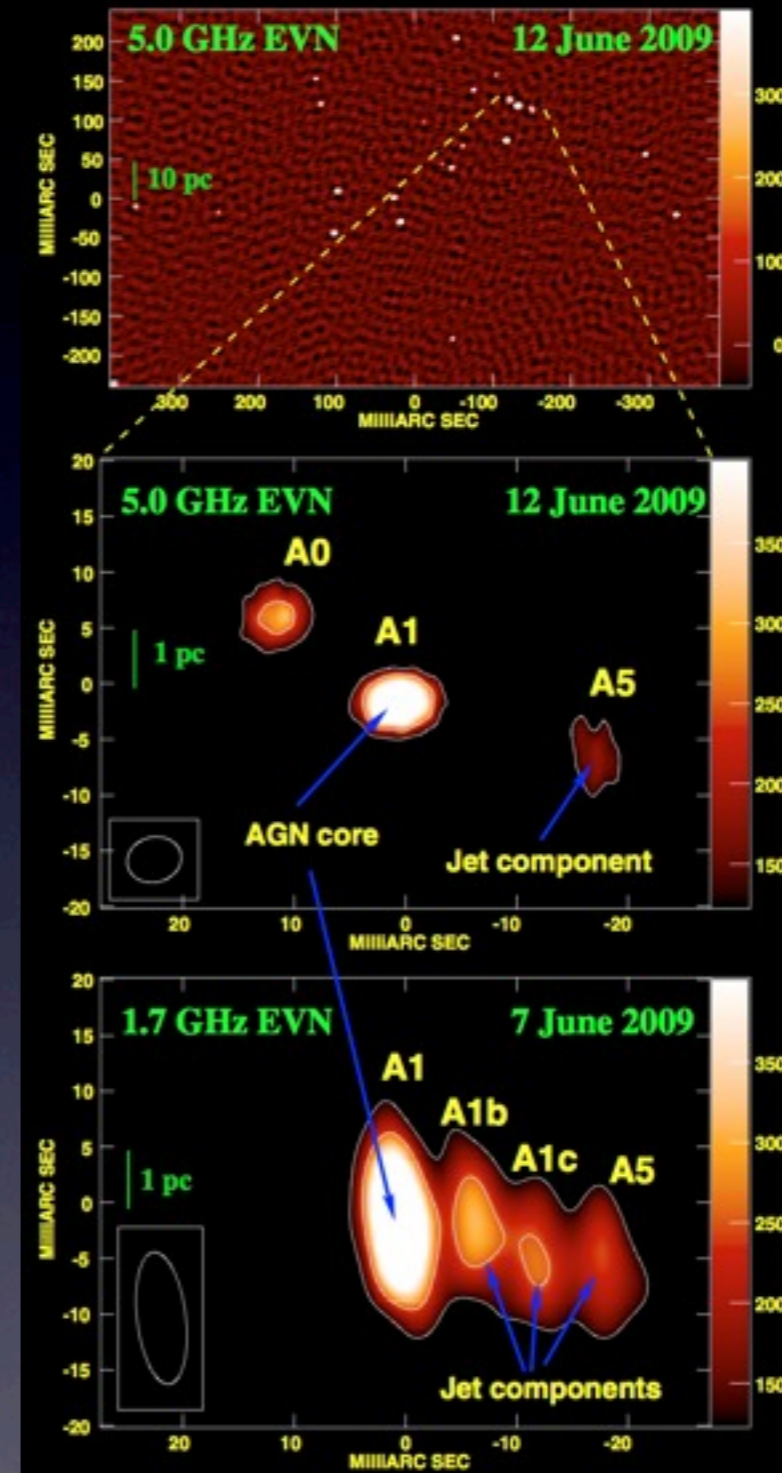

Pérez-Torres et al. 2010

# IC 1623



3.6cm

814nm

435nm

**¡Muchas gracias!**



